

**Paper Models of Polyhedra
Collection 5:
Compounds of Cubes and
Platonic solids with Duals**

- Compound of Two Cubes
- Compound of Three Cubes
- Compound of Four Cubes
- Compound of Five Cubes

Compounds of Platonic Solids with Duals:

- Stella Octangula (Compound of Two Tetrahedra)
- Compound of Cube and Octahedron
- Compound of Dodecahedron and Icosahedron

www.polyhedra.net

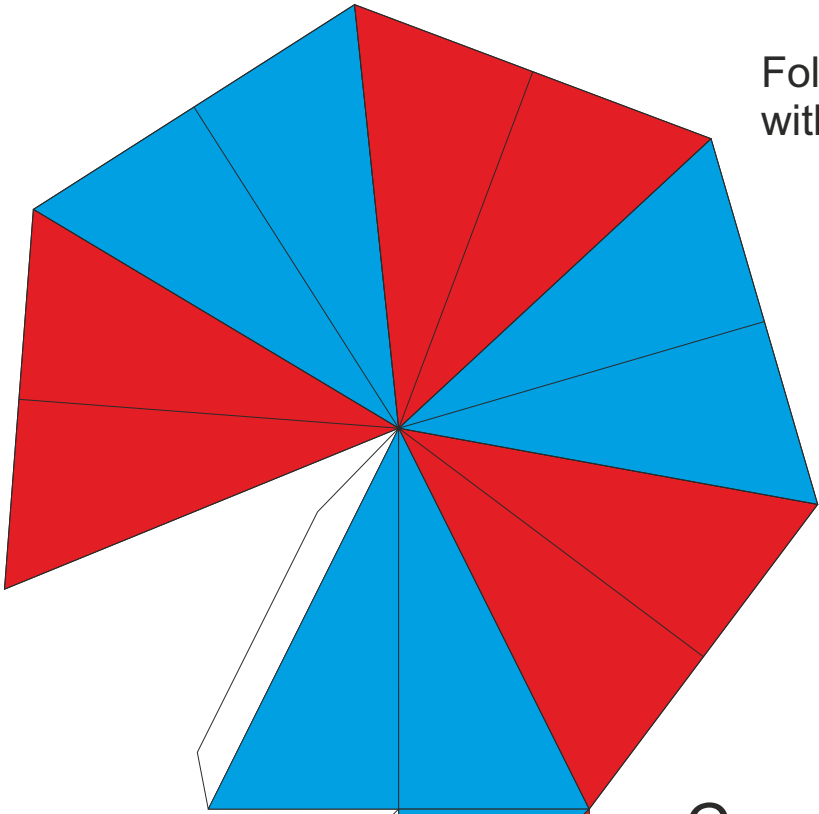

Fold the lines
with a rightangle
backwards
fold the other
lines forwards

Compound of two
Cubes

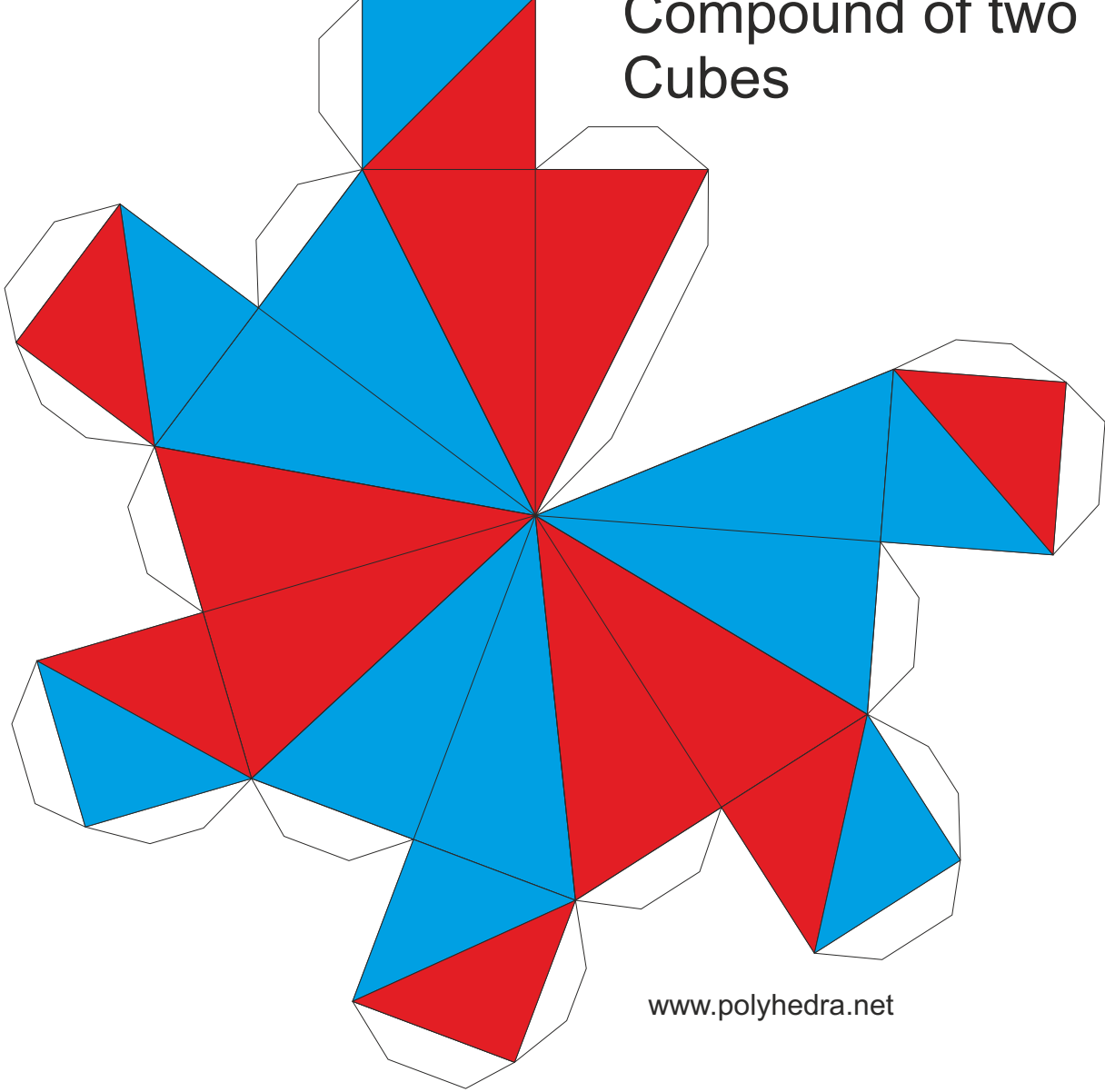

Compound of Three Cubes

(Small version)

Fold the dotted lines forwards

Fold the other lines backwards

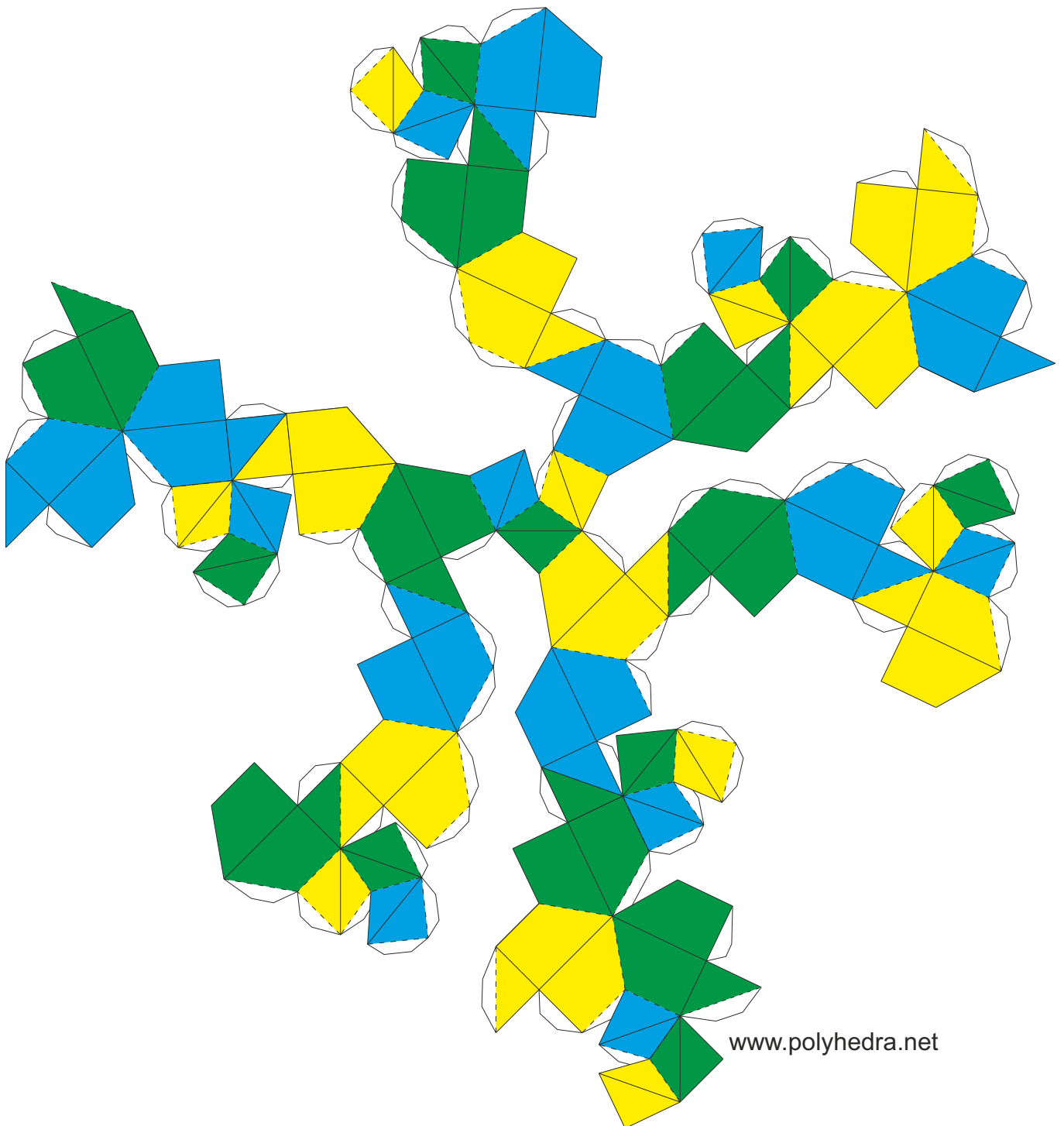

Compound of Three Cubes

(Large version made out of 7 pieces)

Fold the dotted lines forwards

Fold the other lines backwards

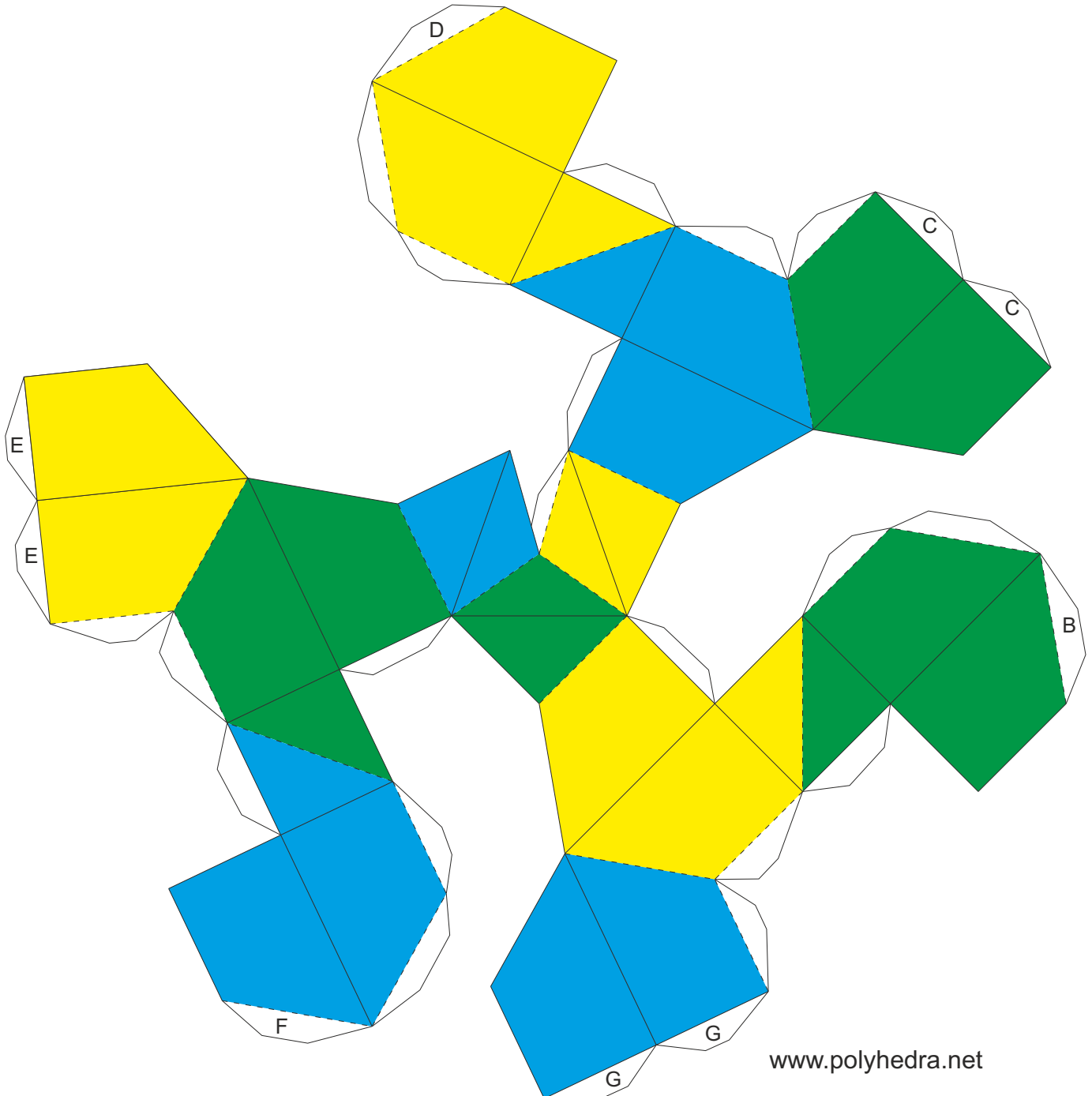

B

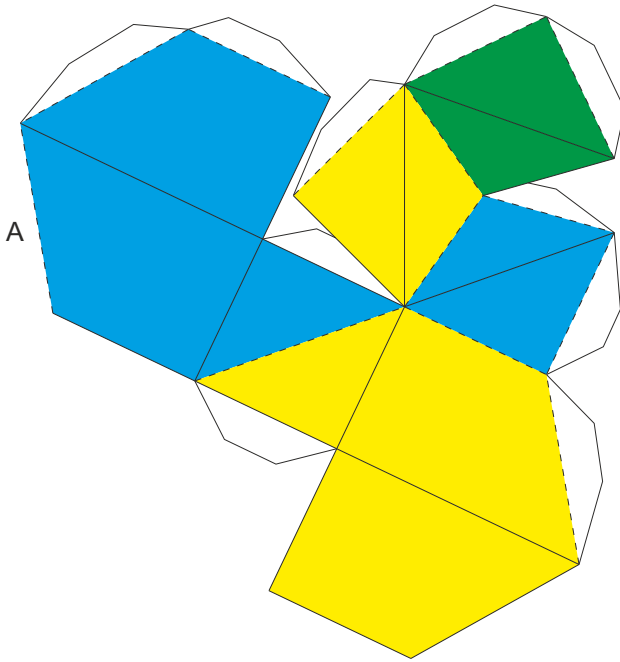

C

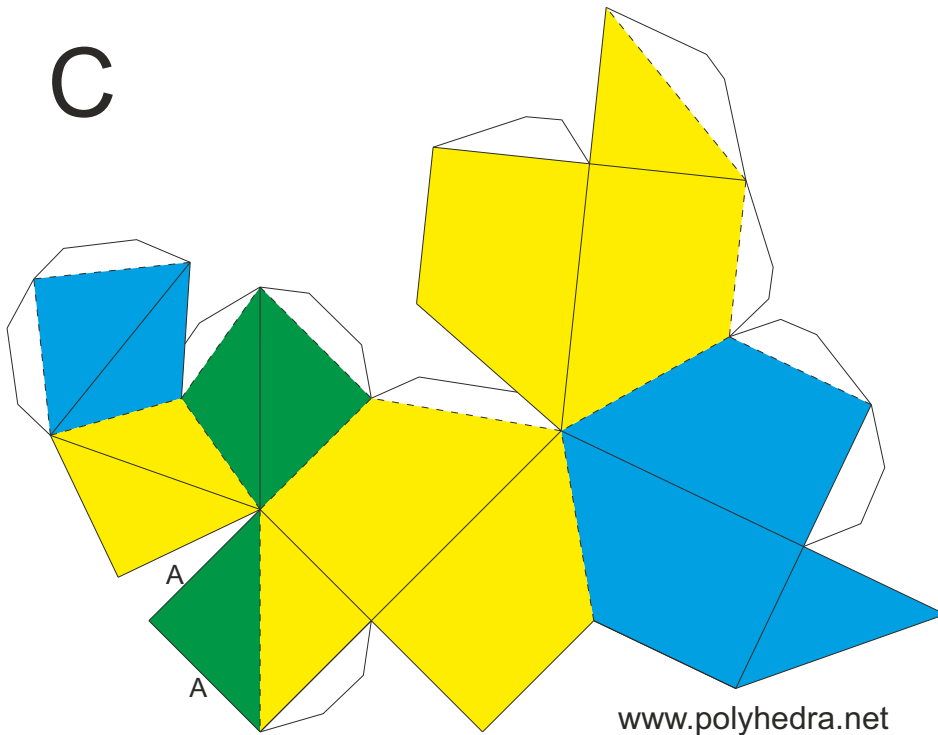

D

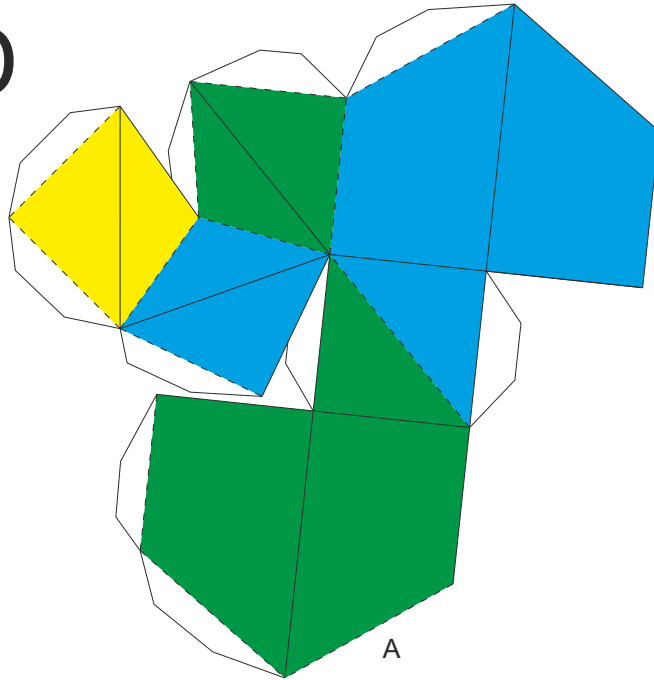

E

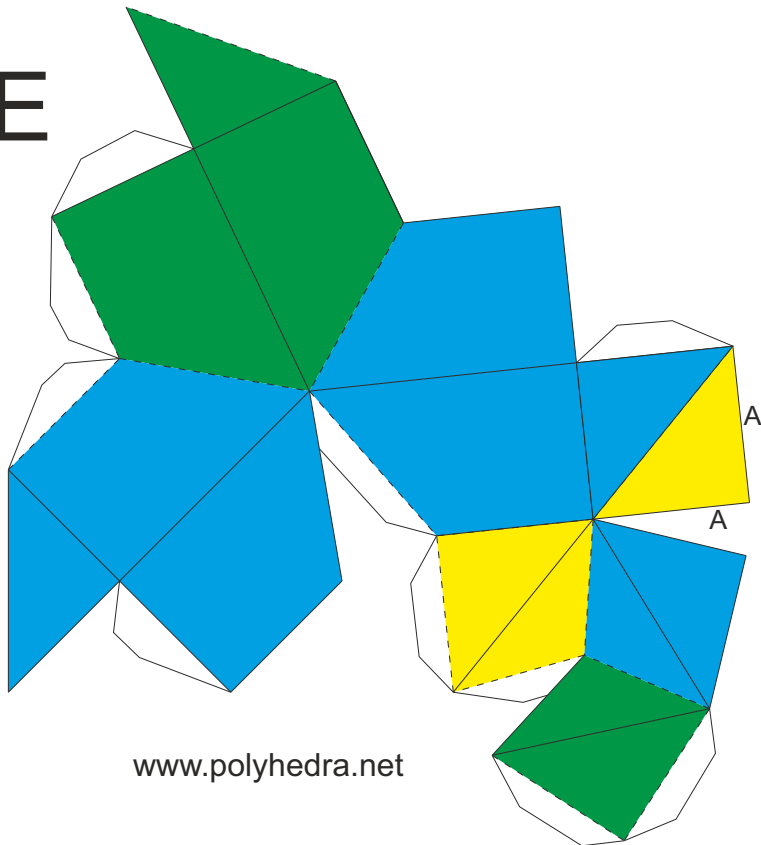

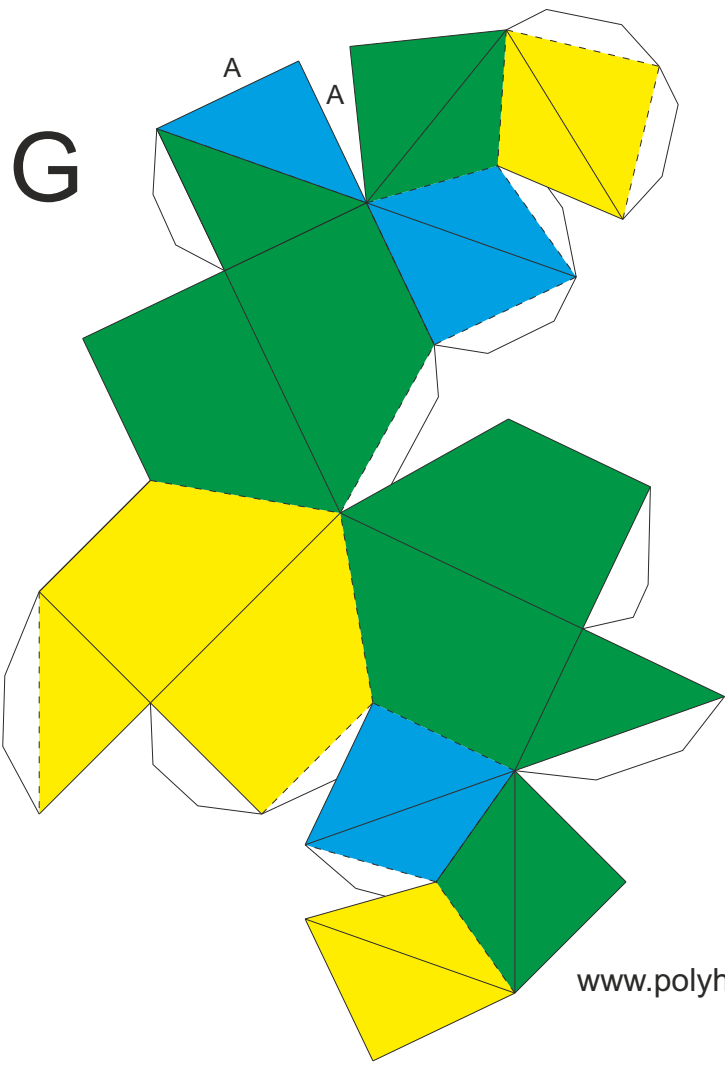
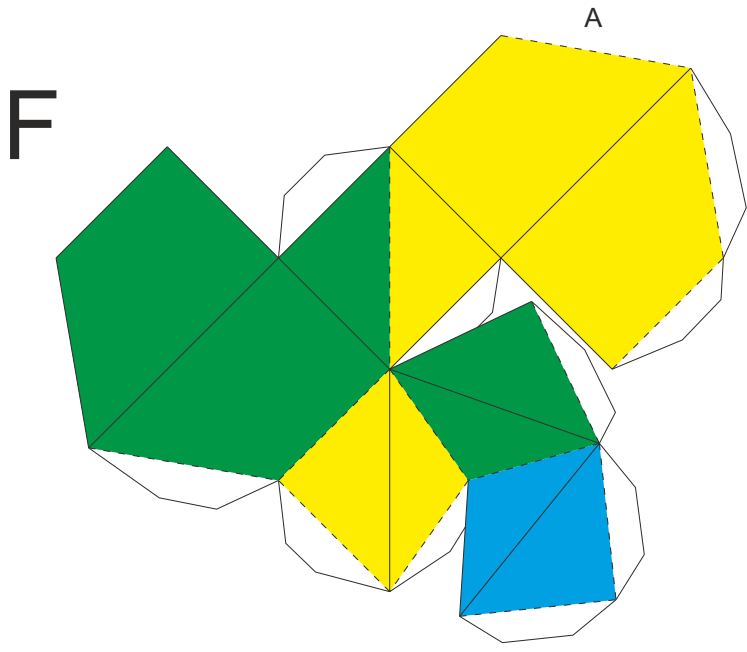

Compound of four cubes

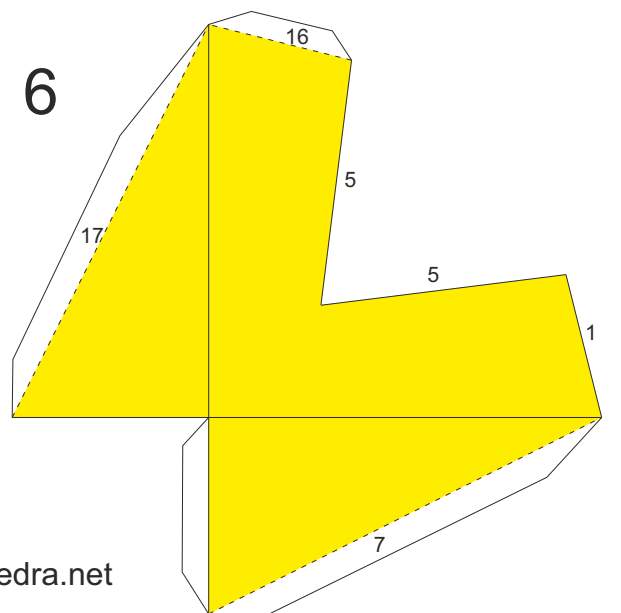
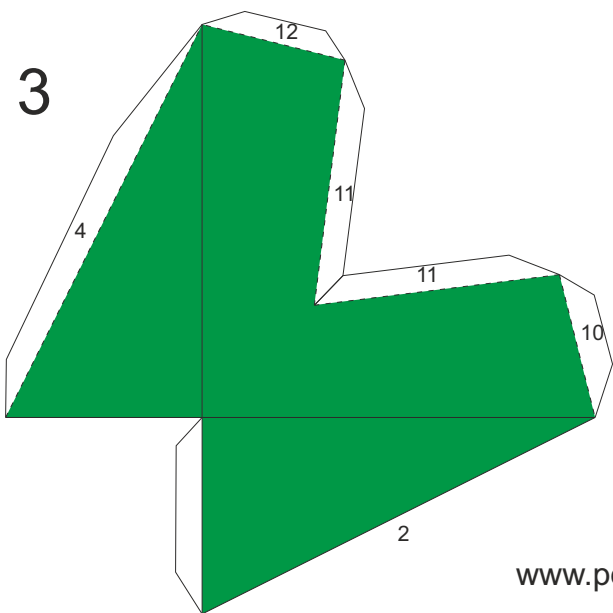
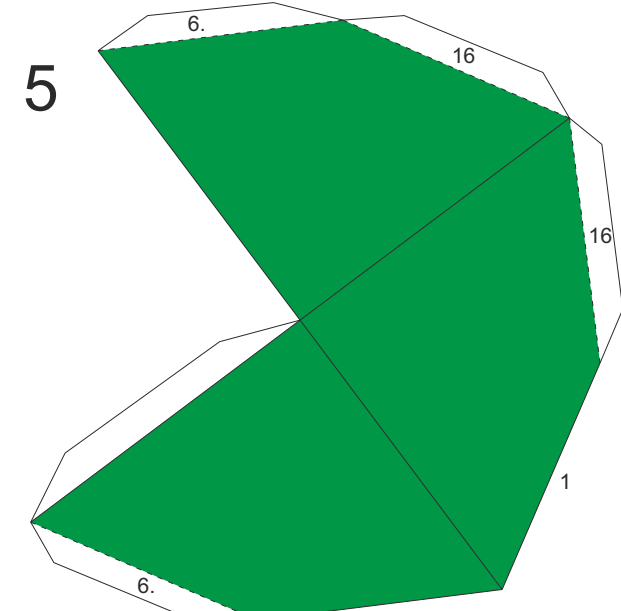
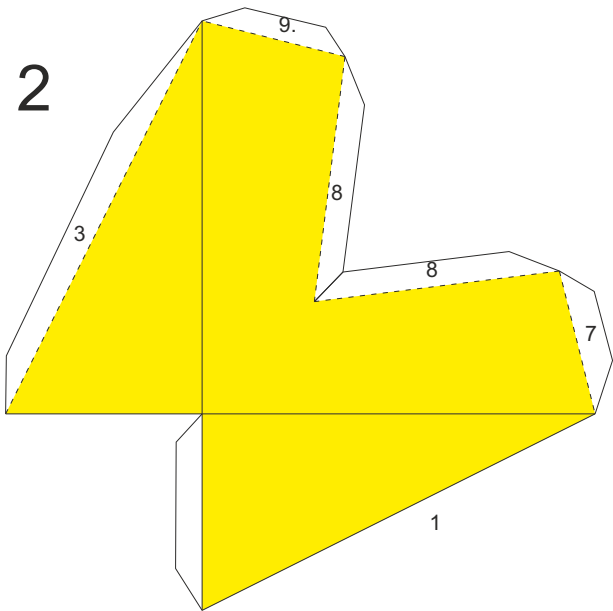
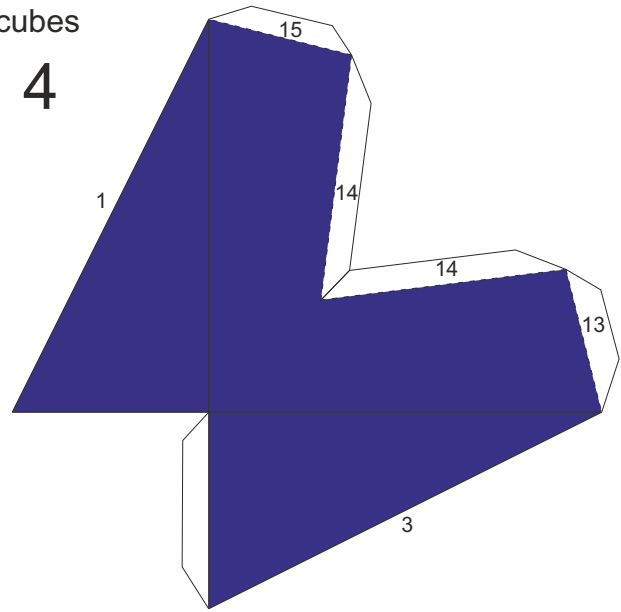
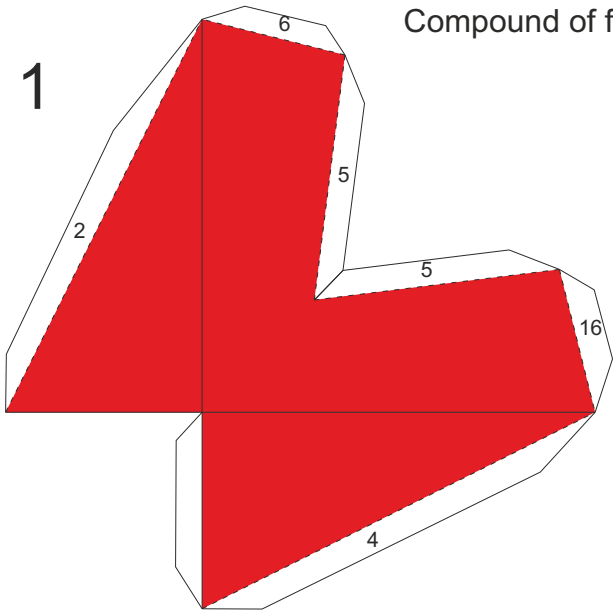

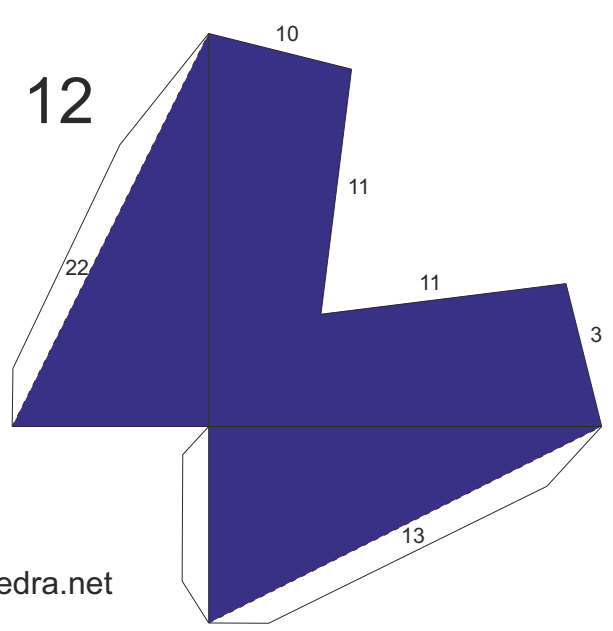
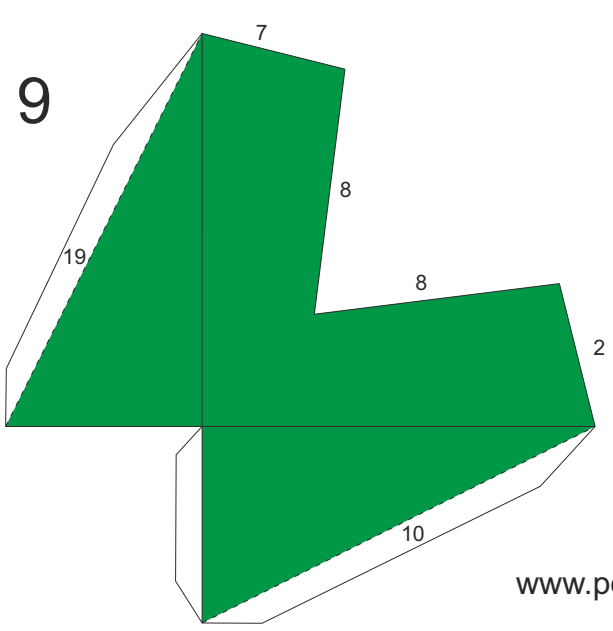
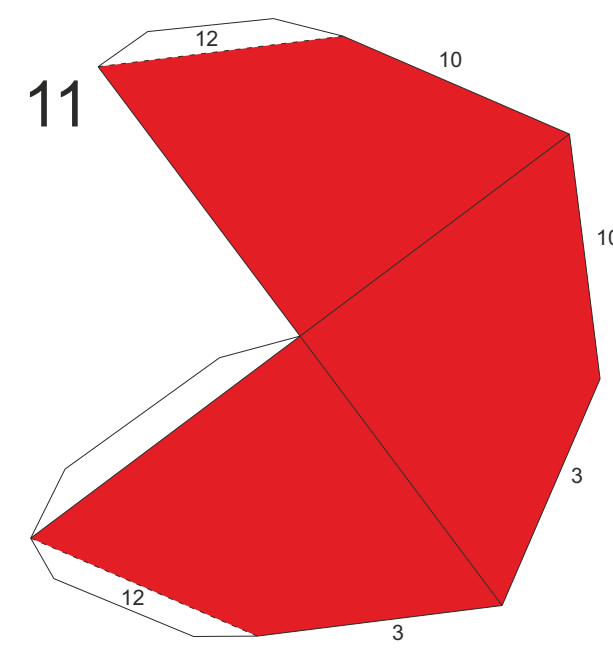
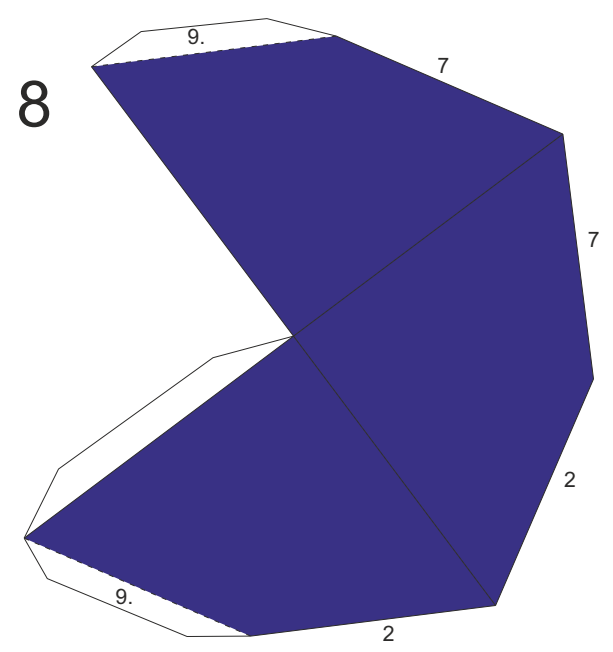
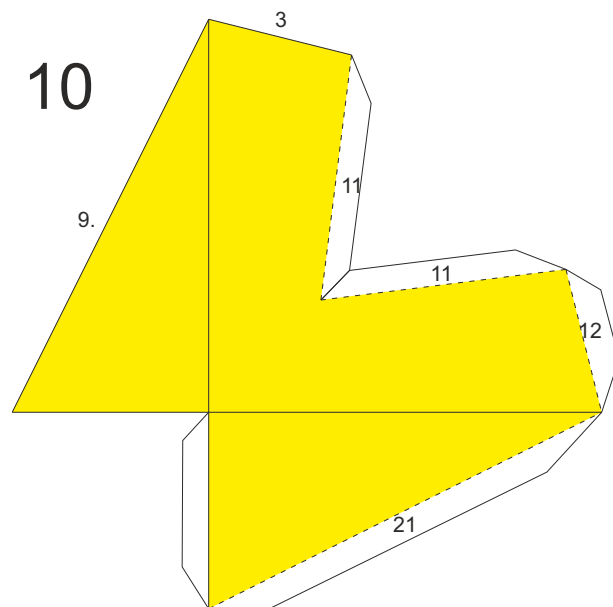
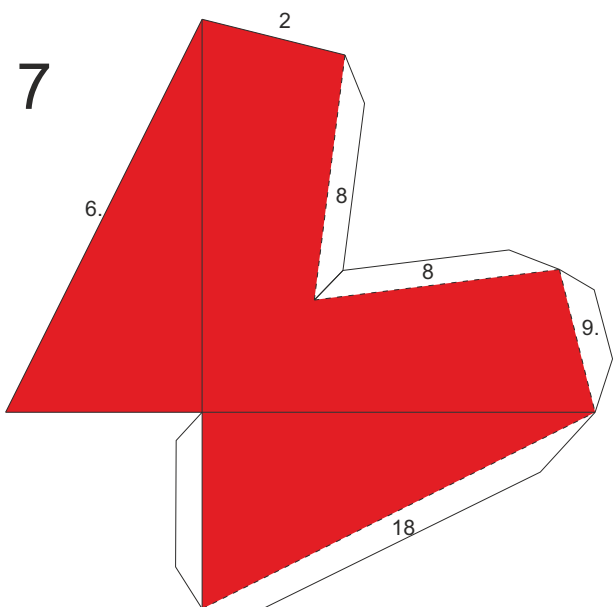

Compound of four cubes

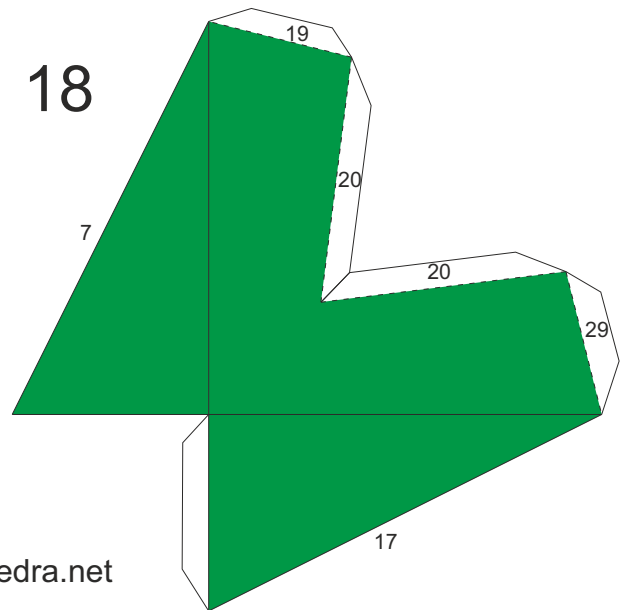
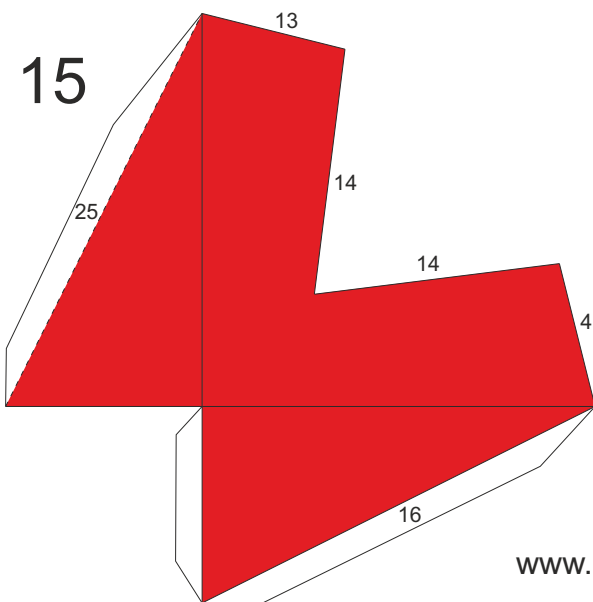
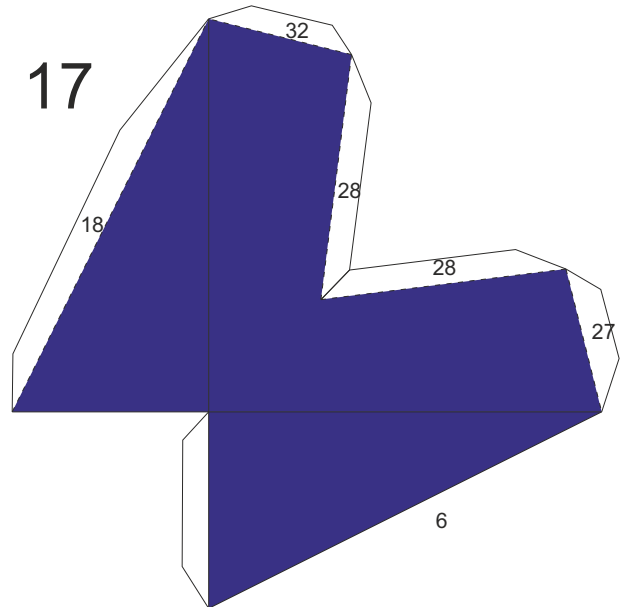
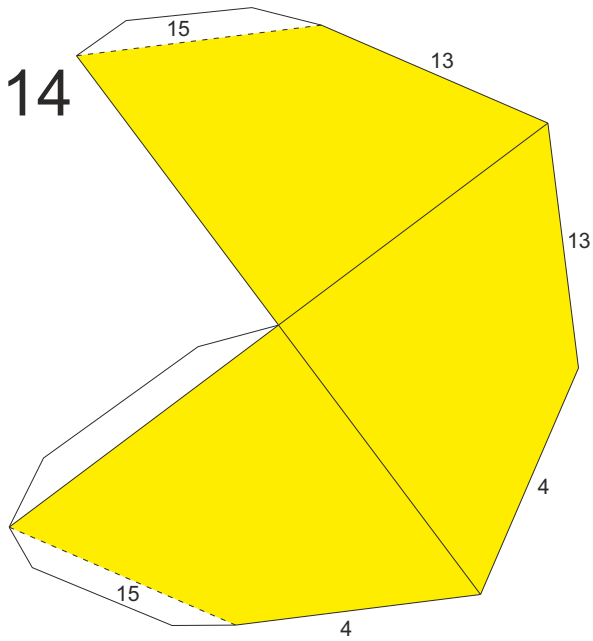
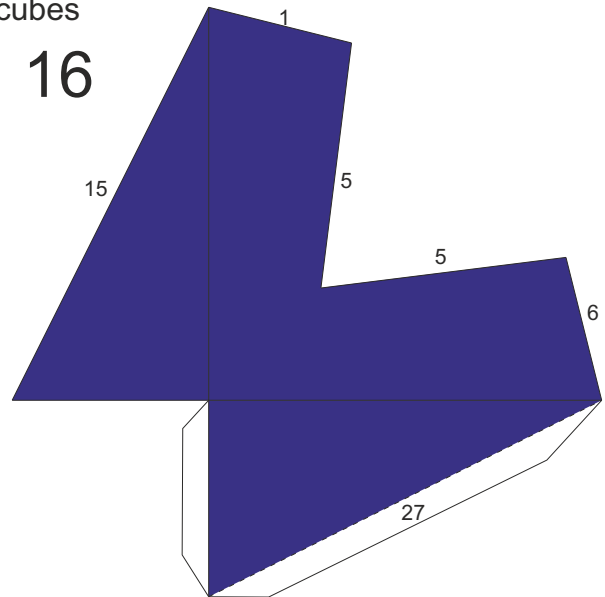
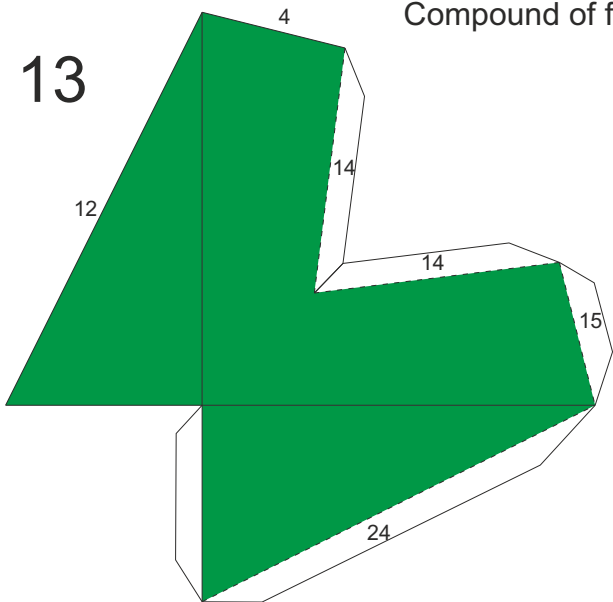

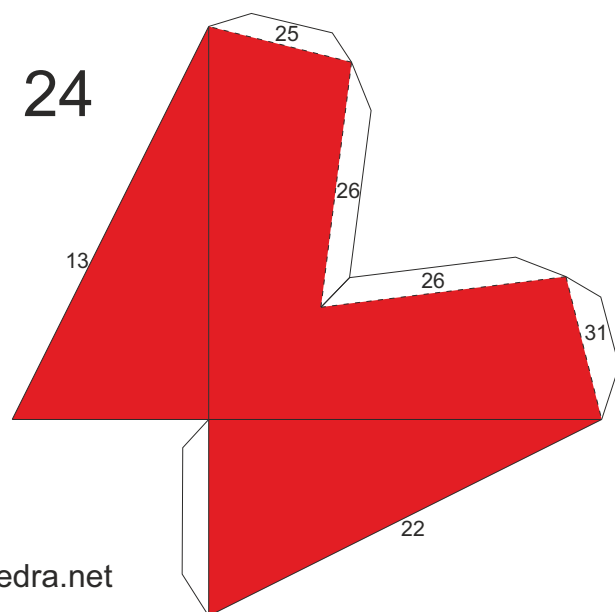
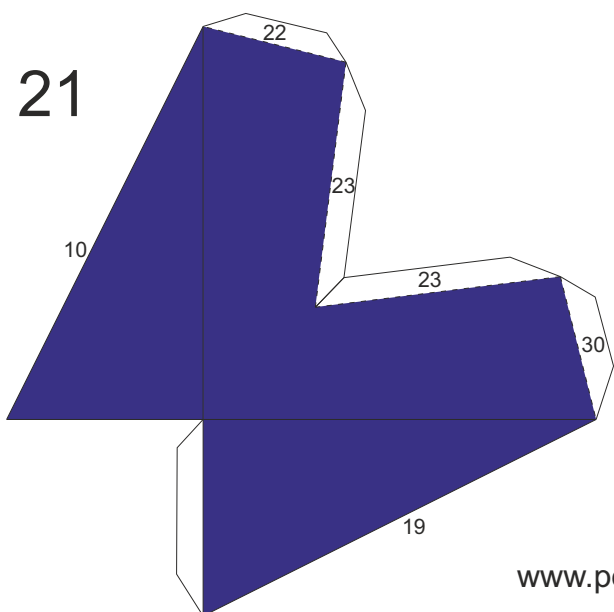
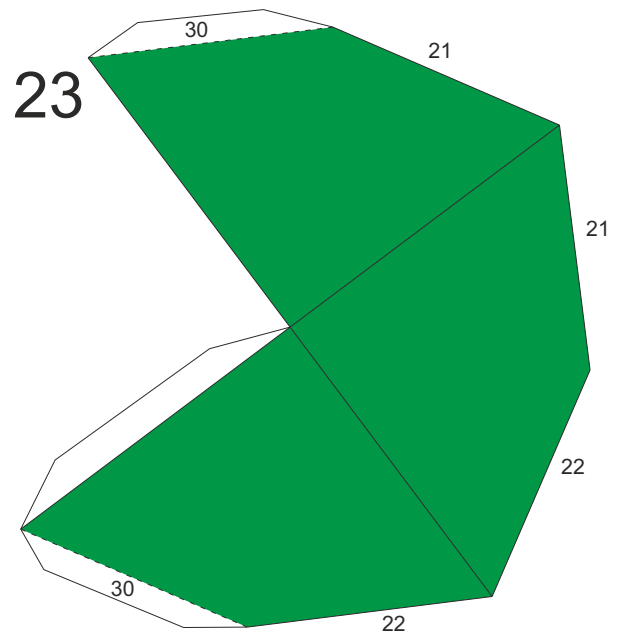
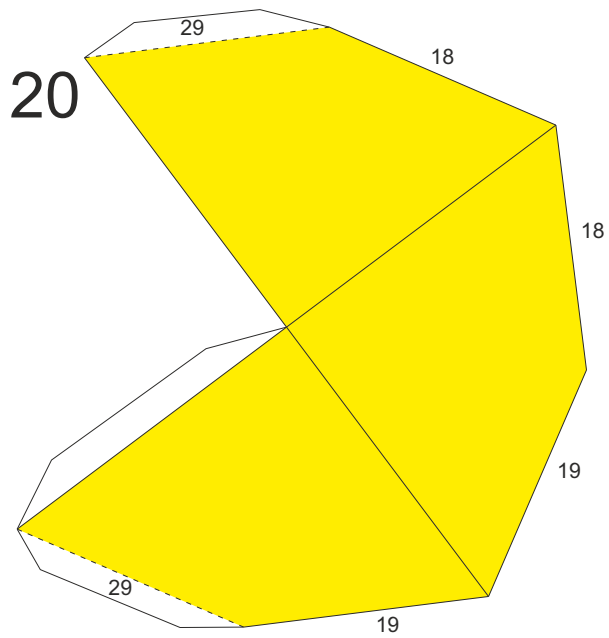
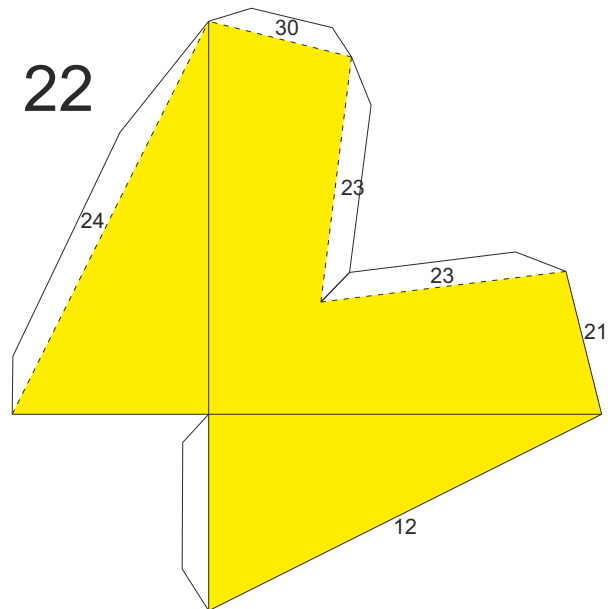
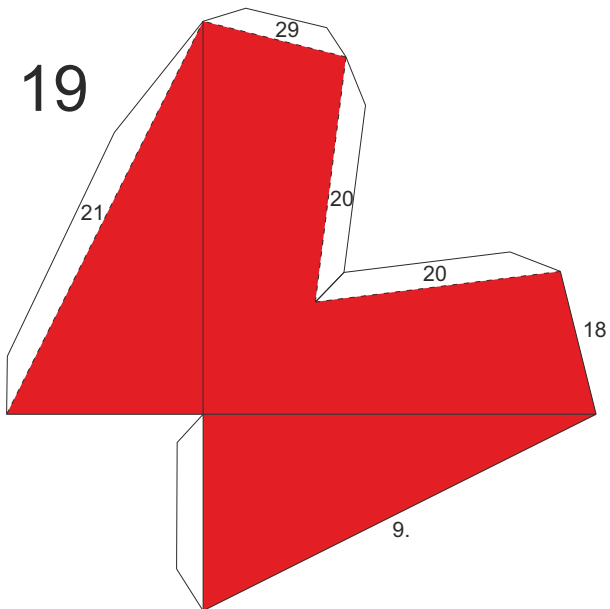

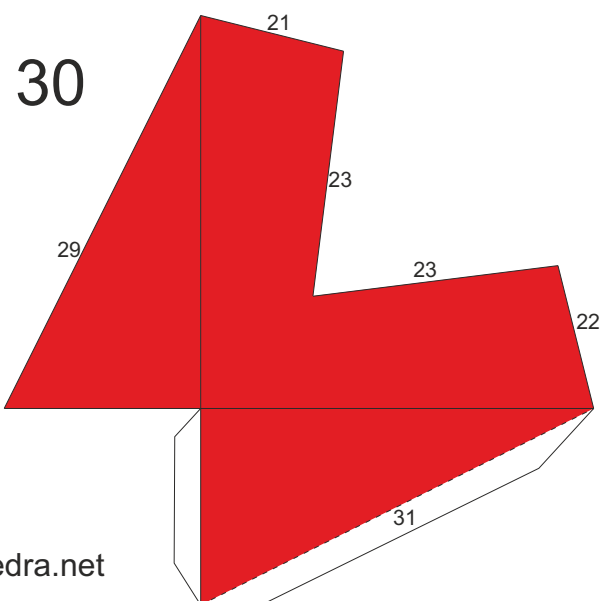
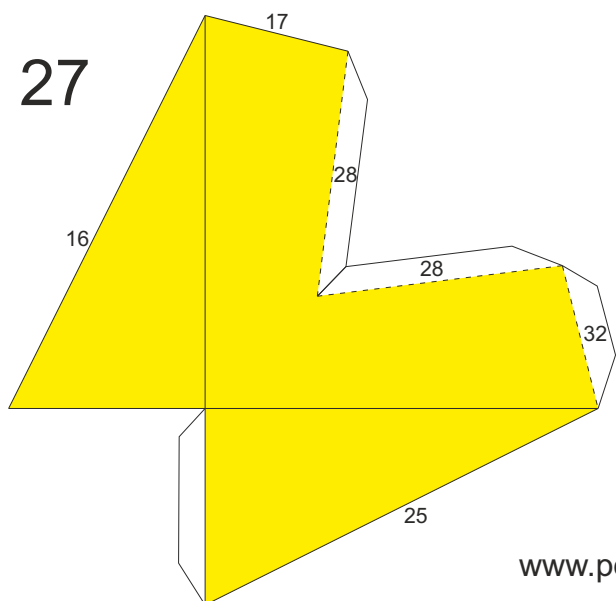
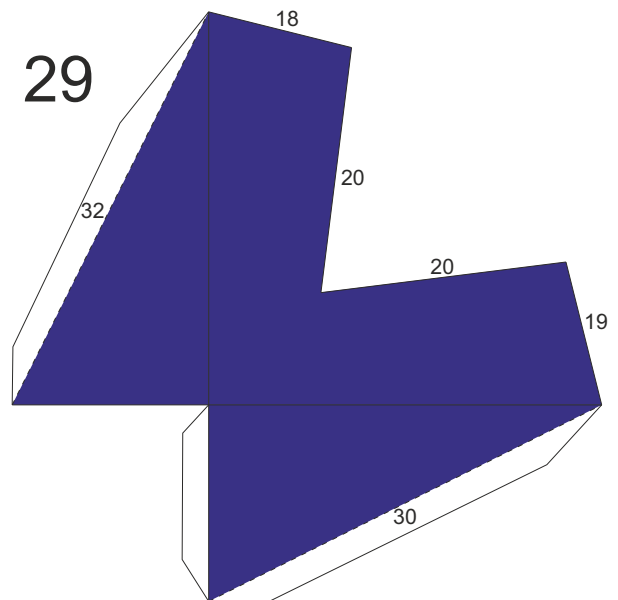
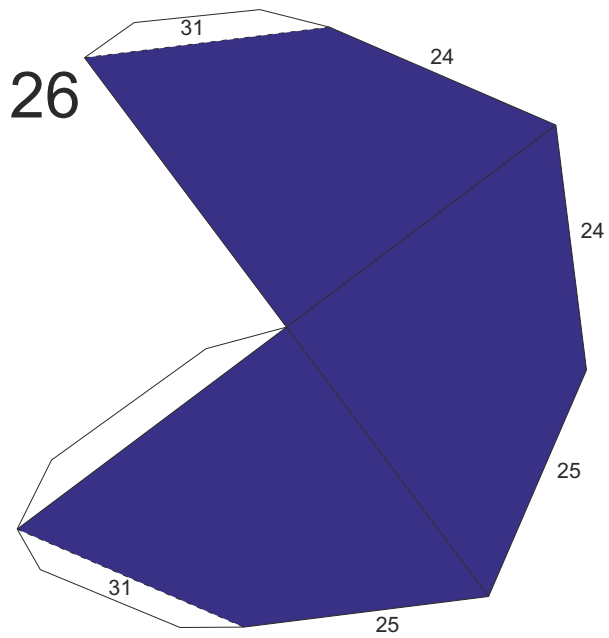
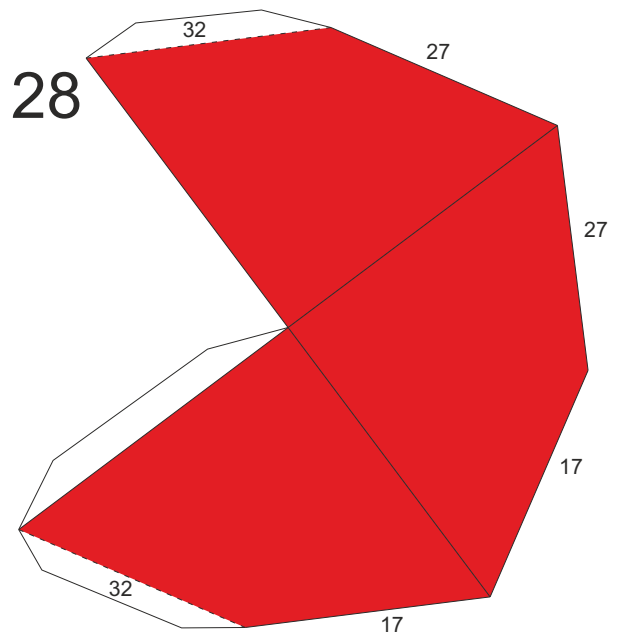
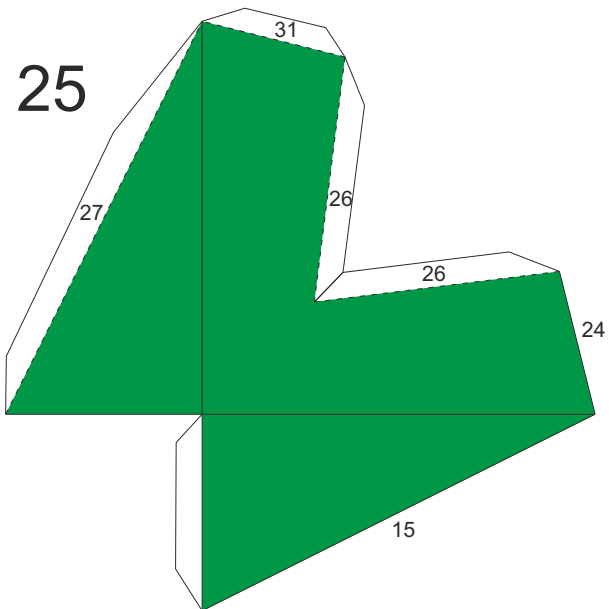

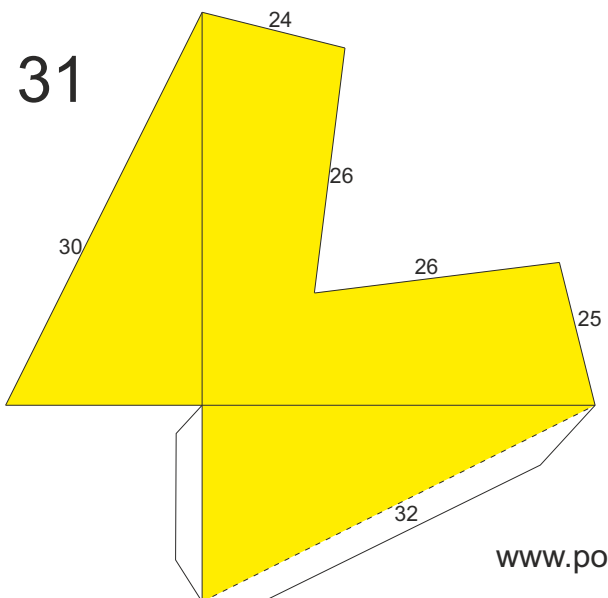

www.polyhedra.net

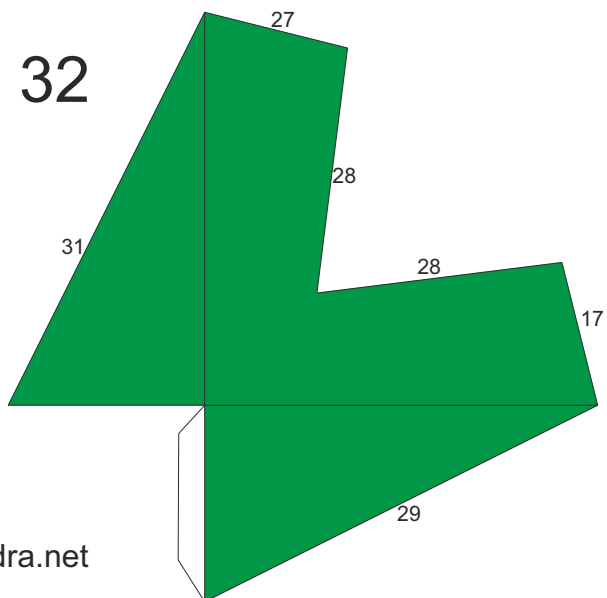

Compound of Five Cubes

small version made out of one piece

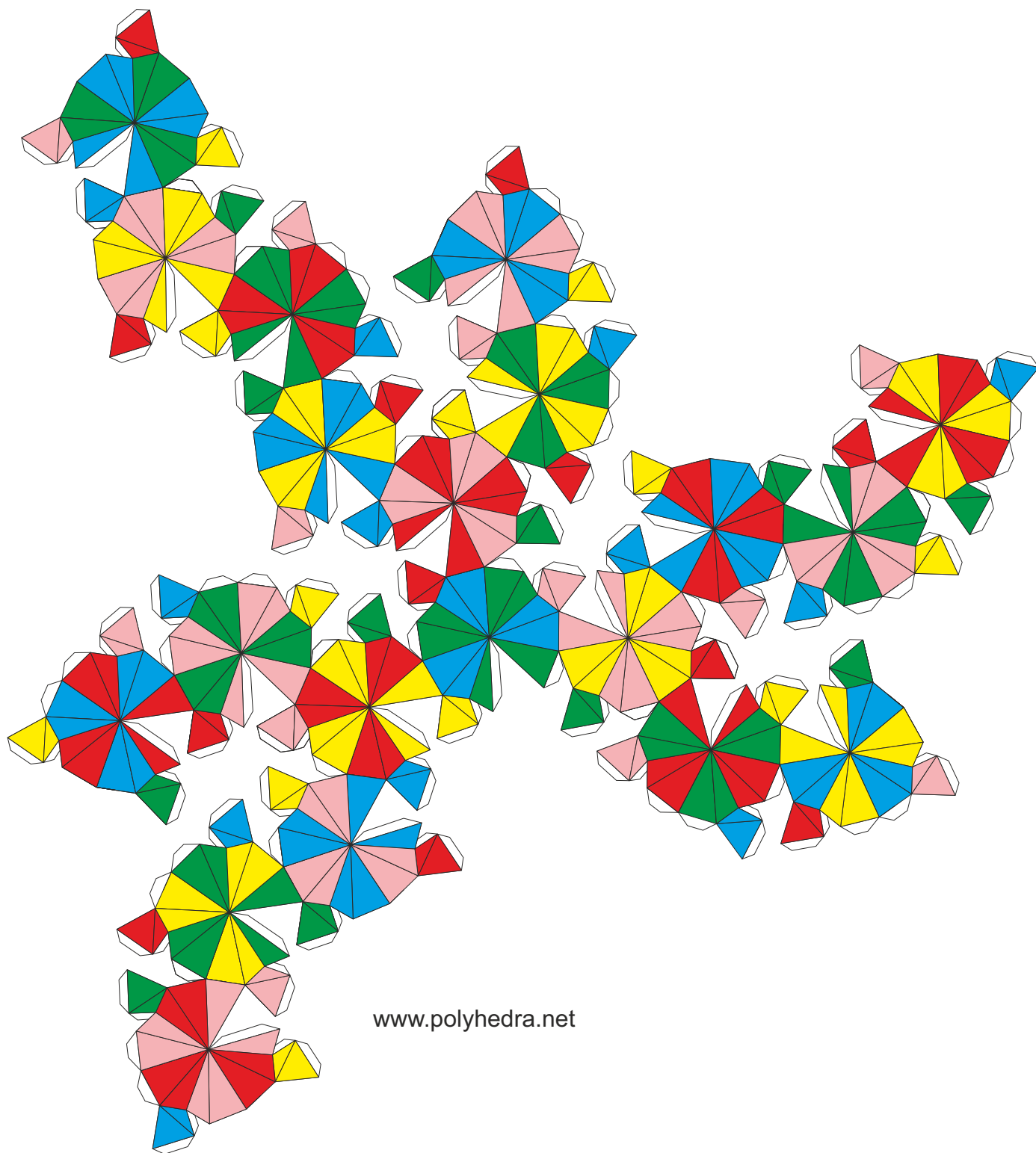

www.polyhedra.net

Instructions compound of five cubes:

Cut and fold the piece(s) of paper.
Glue the part without tabs around it last.
This is the top part of piece F. This one
opposites the center part of piece A.

Below an example of a part

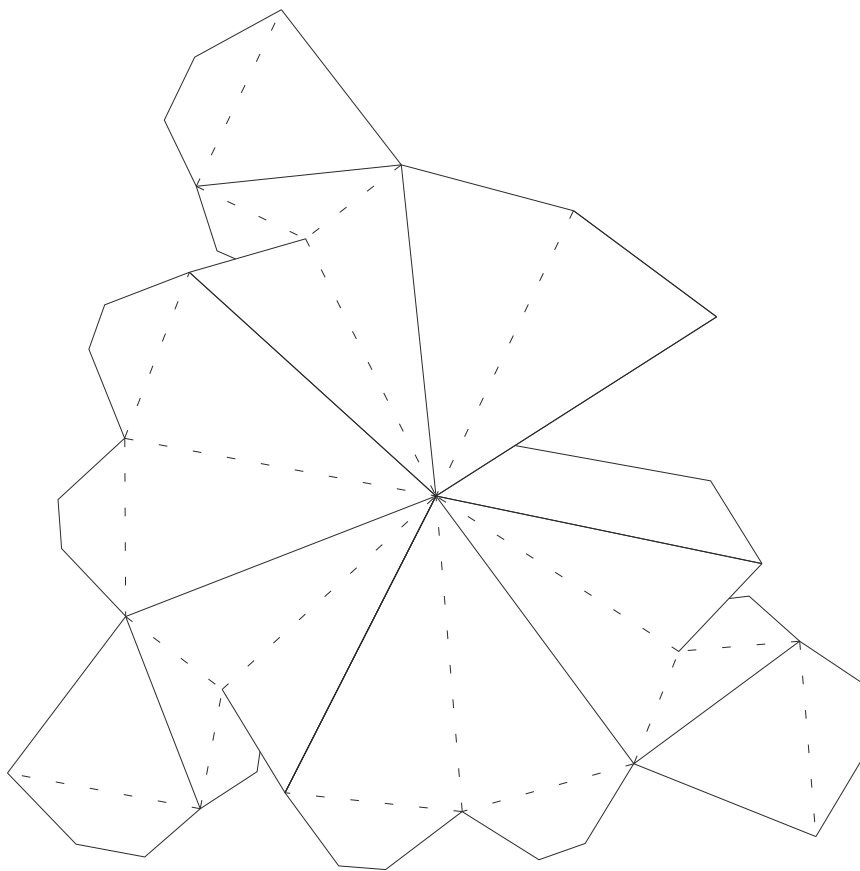

- - - - - Fold forwards
————— Fold backwards

Compound of Five Cubes

large version made out of seven pieces

A

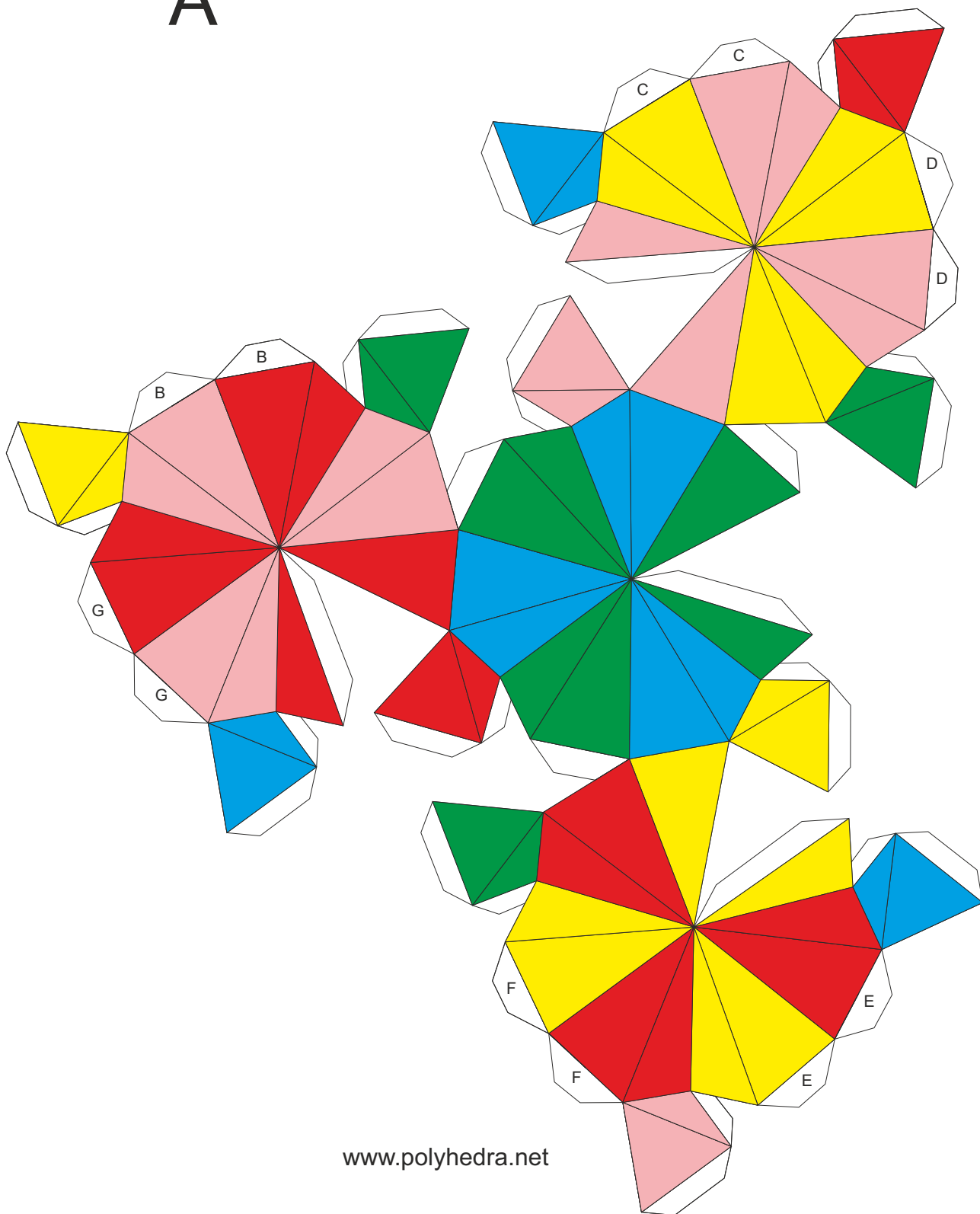

B

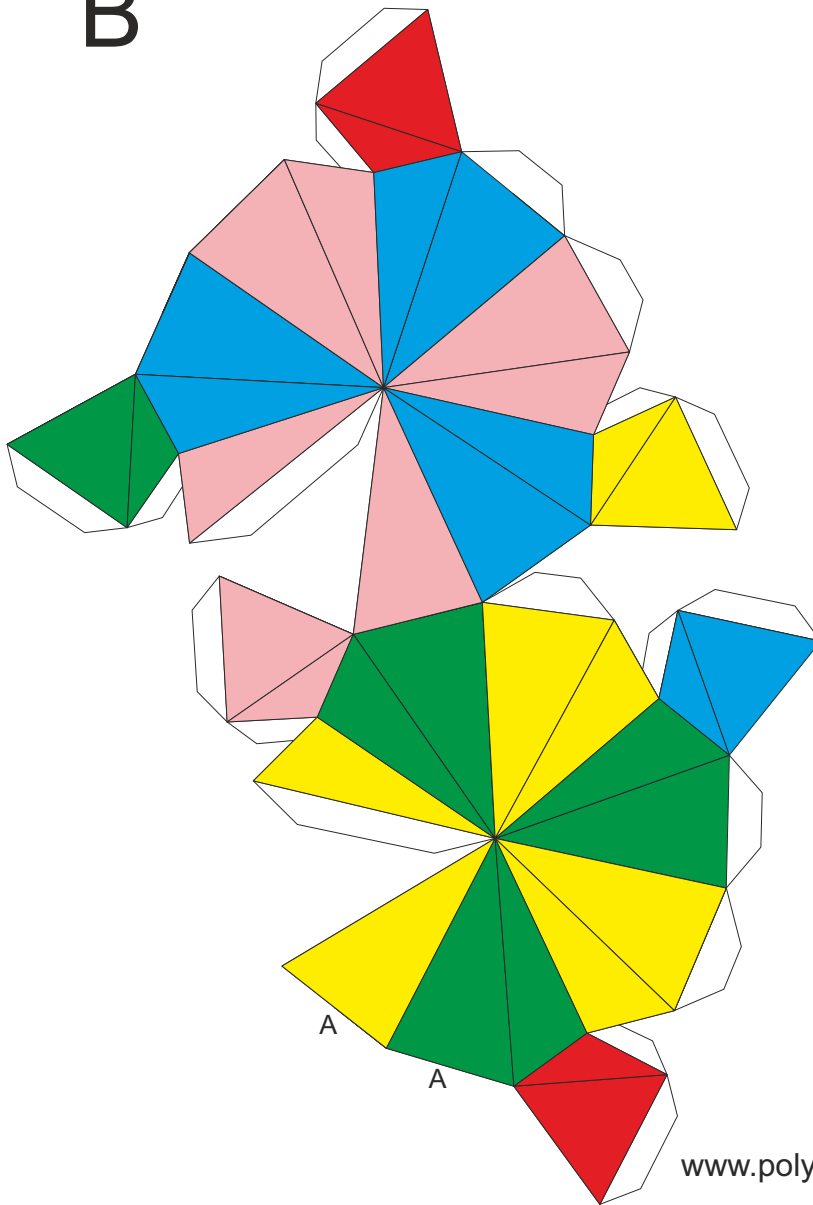

C

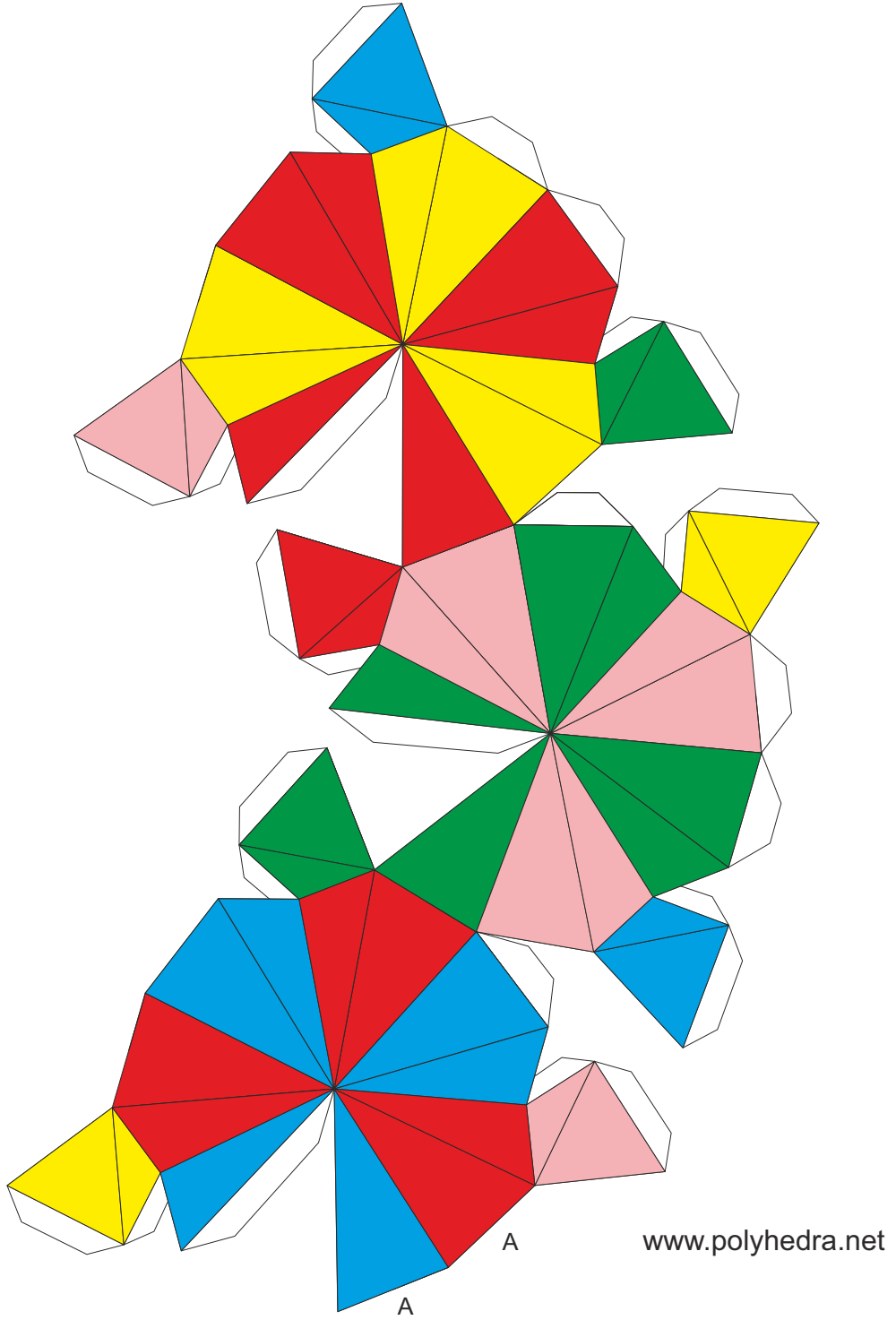

D

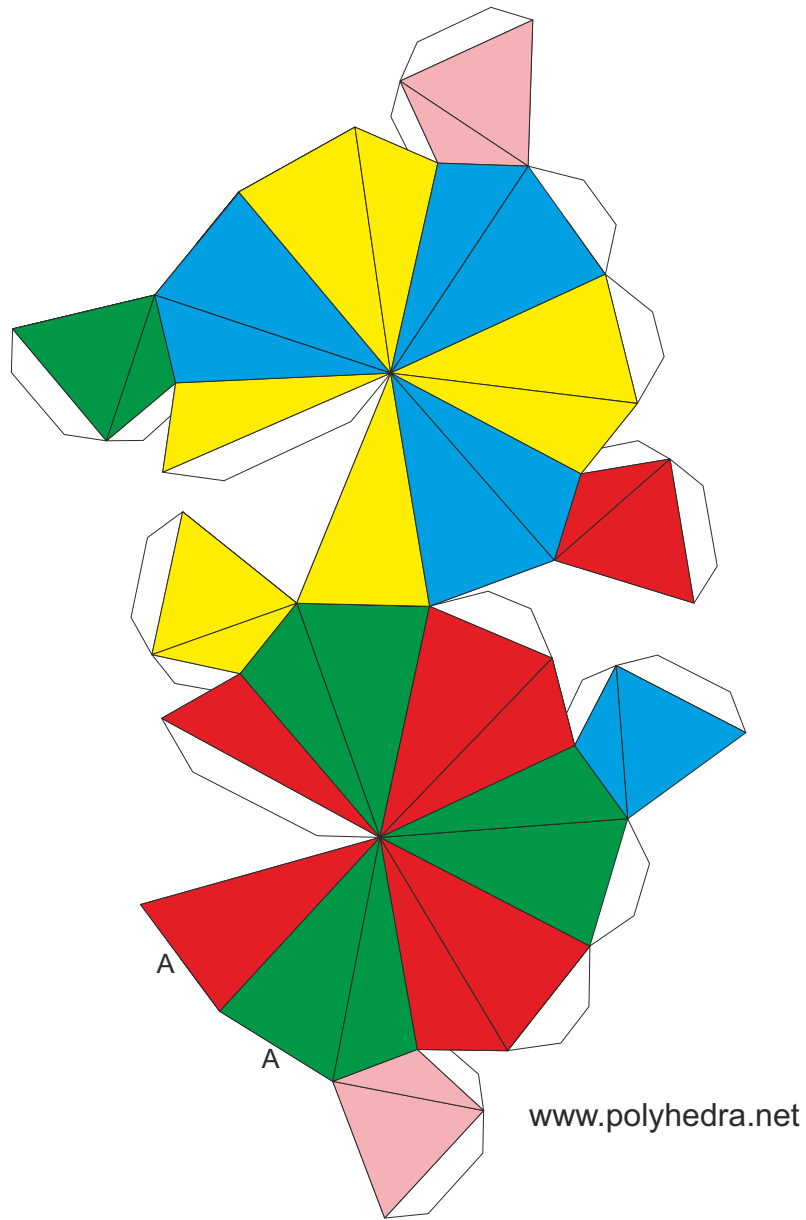

E

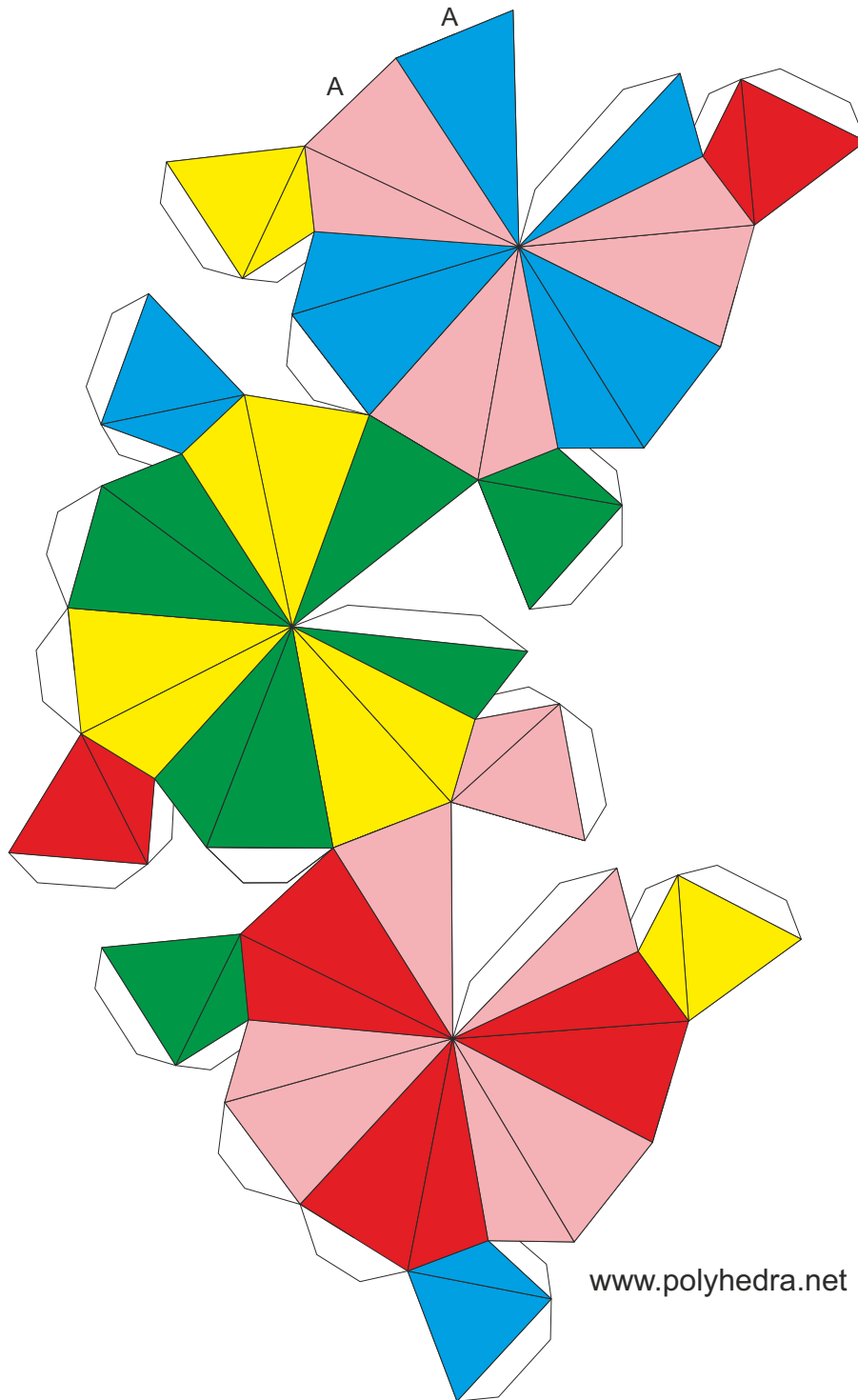

F

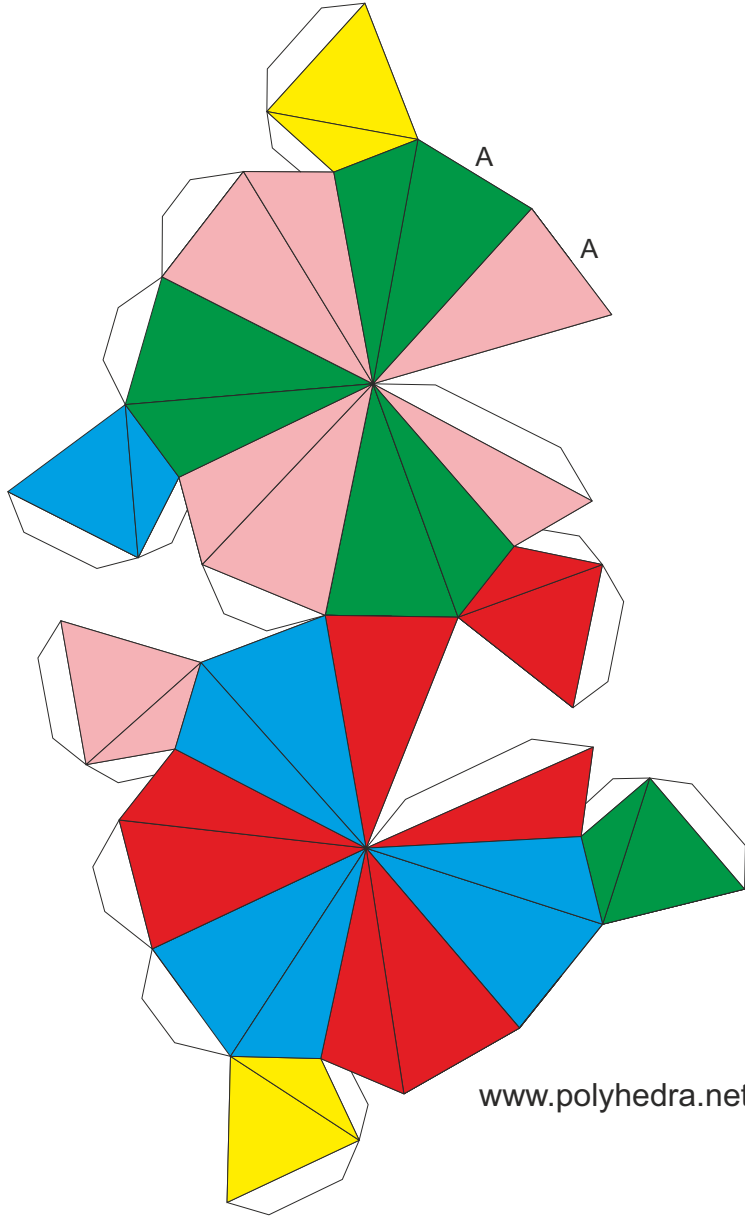

G

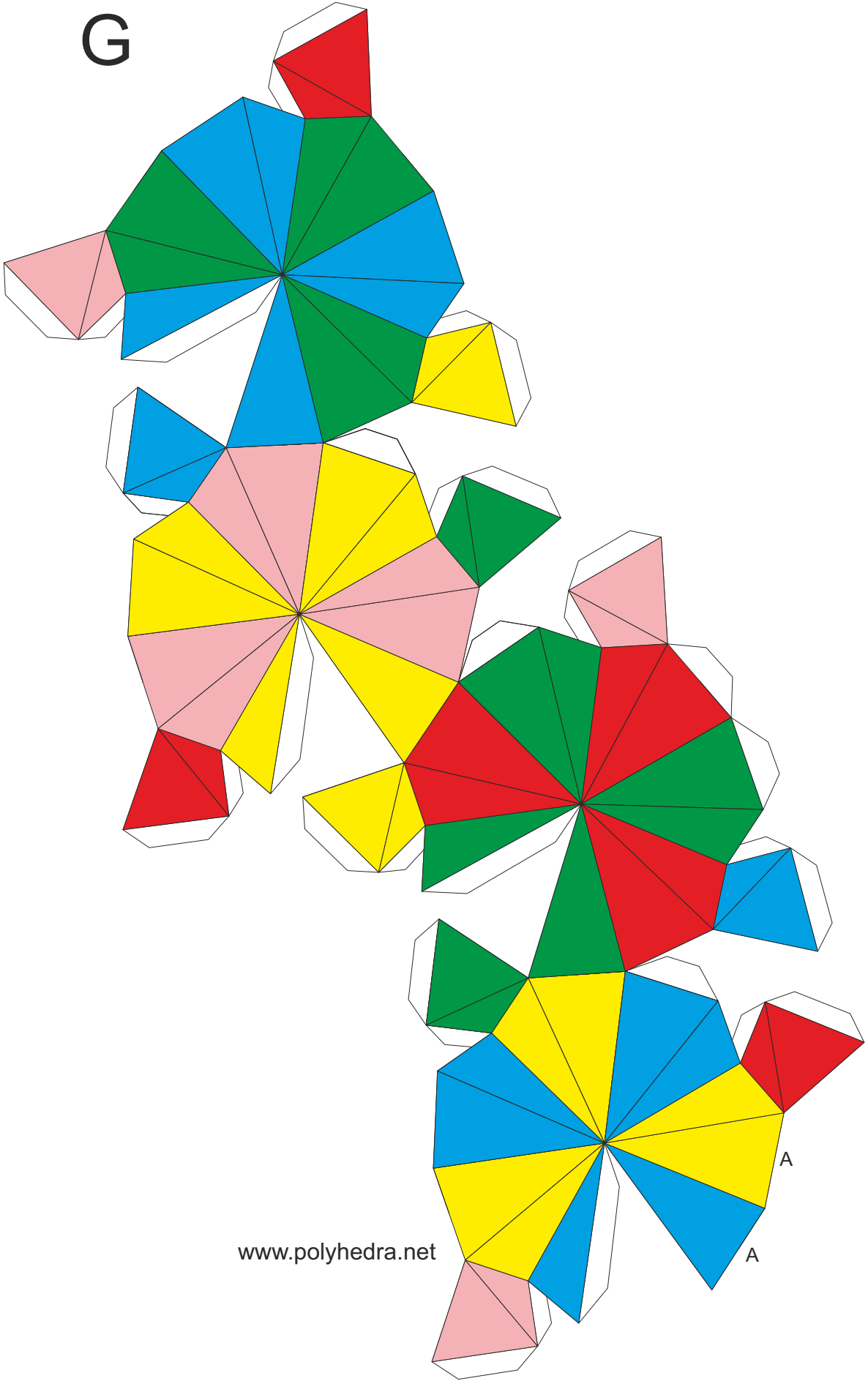

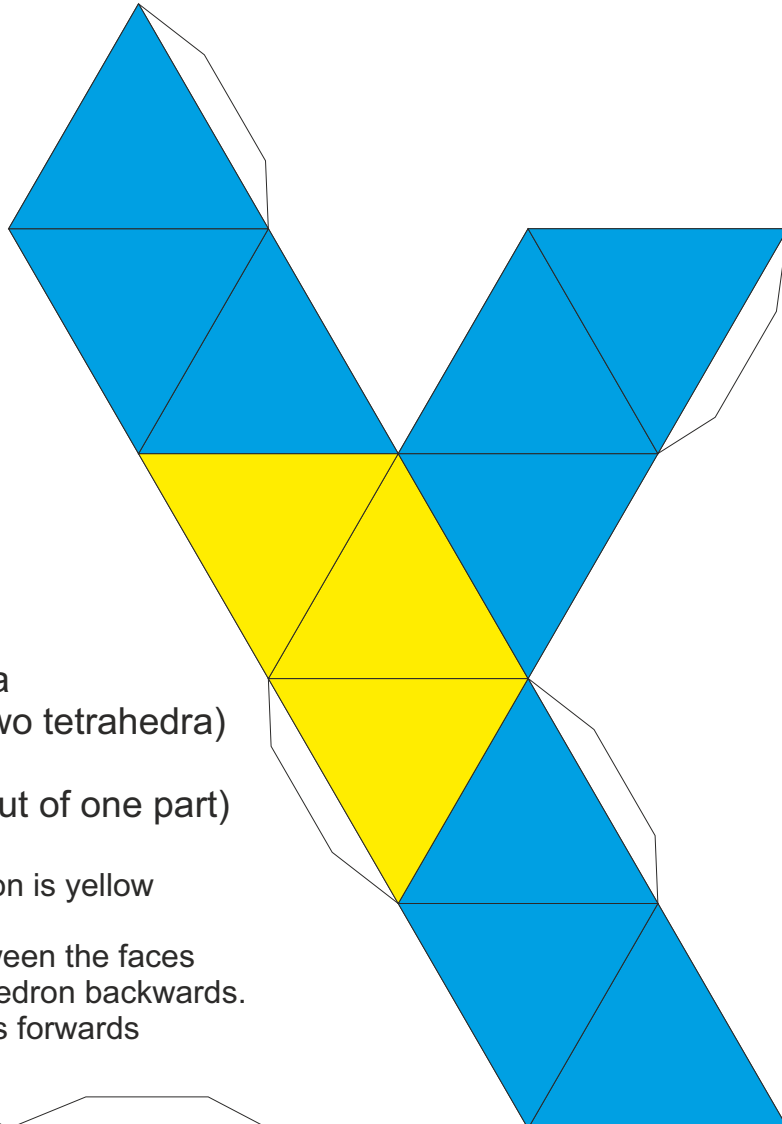

Stella Octangula
(compound of two tetrahedra)

(small version out of one part)

The first tetrahedron is yellow
the second is blue
Fold the lines between the faces
of the same tetrahedron backwards.
Fold the other lines forwards

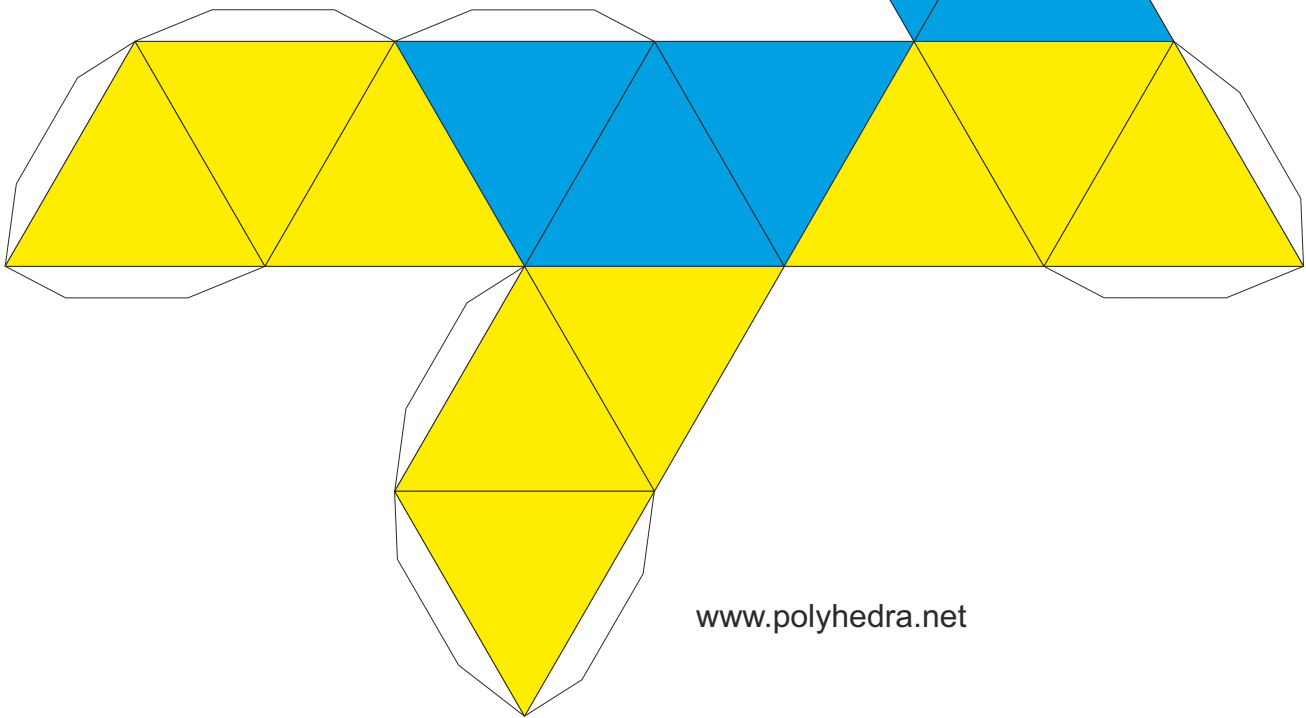

A

Stella Octangula
(compound of two tetrahedra)

(Large version made out of three pieces)

The first tetrahedron is yellow
the second is blue
Fold the lines between the faces
of the same tetrahedron backwards.
Fold the other lines forwards

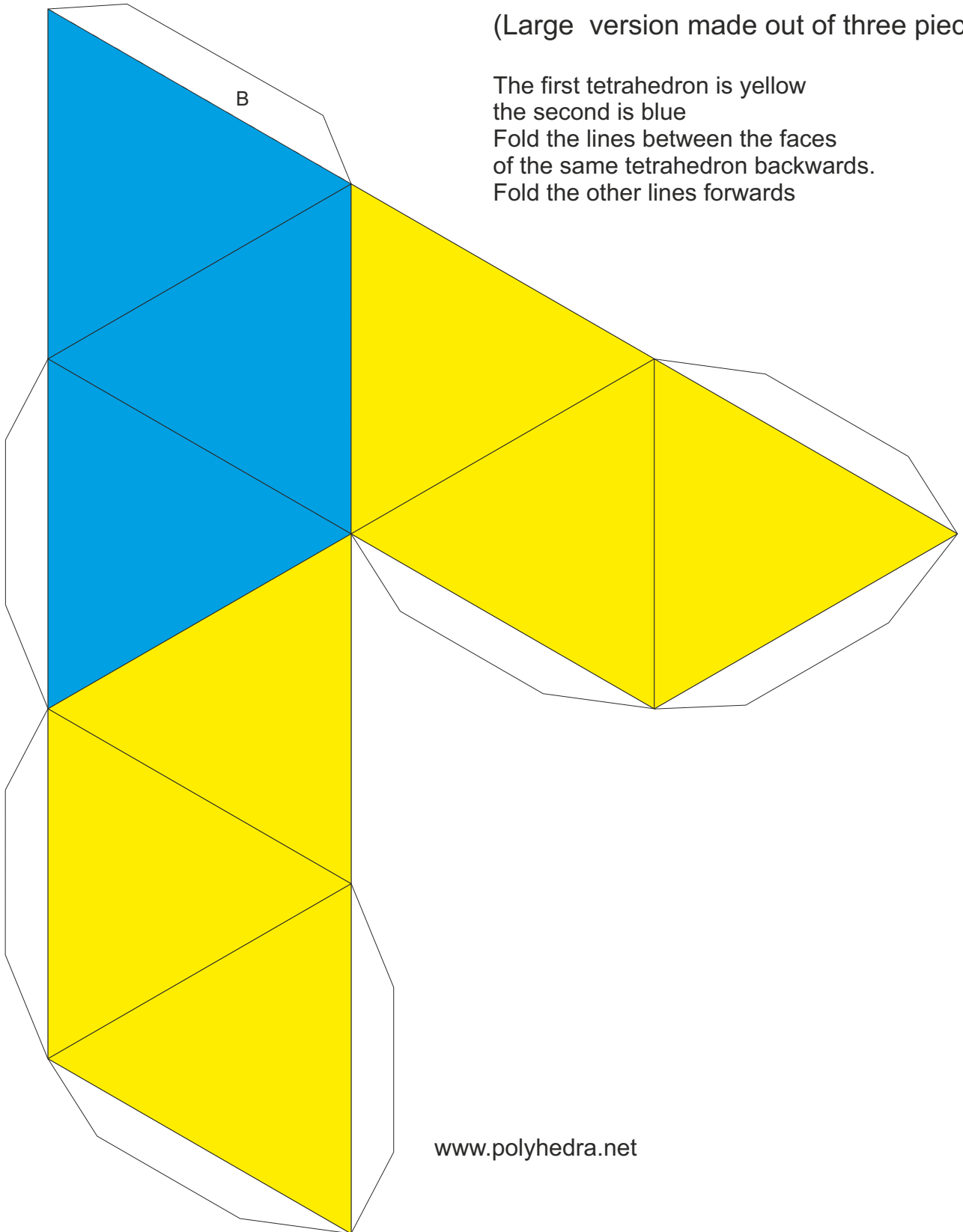

B

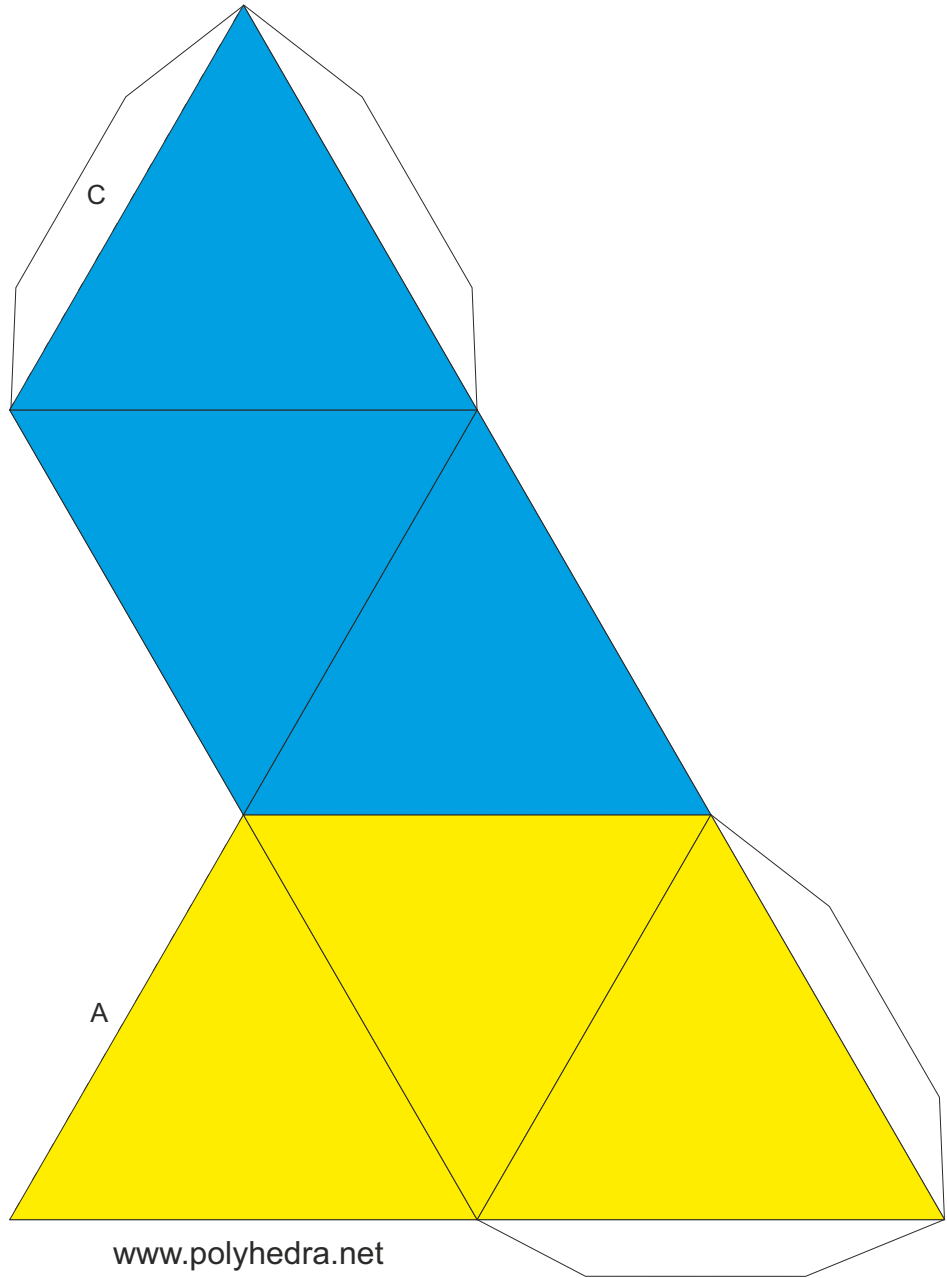

C

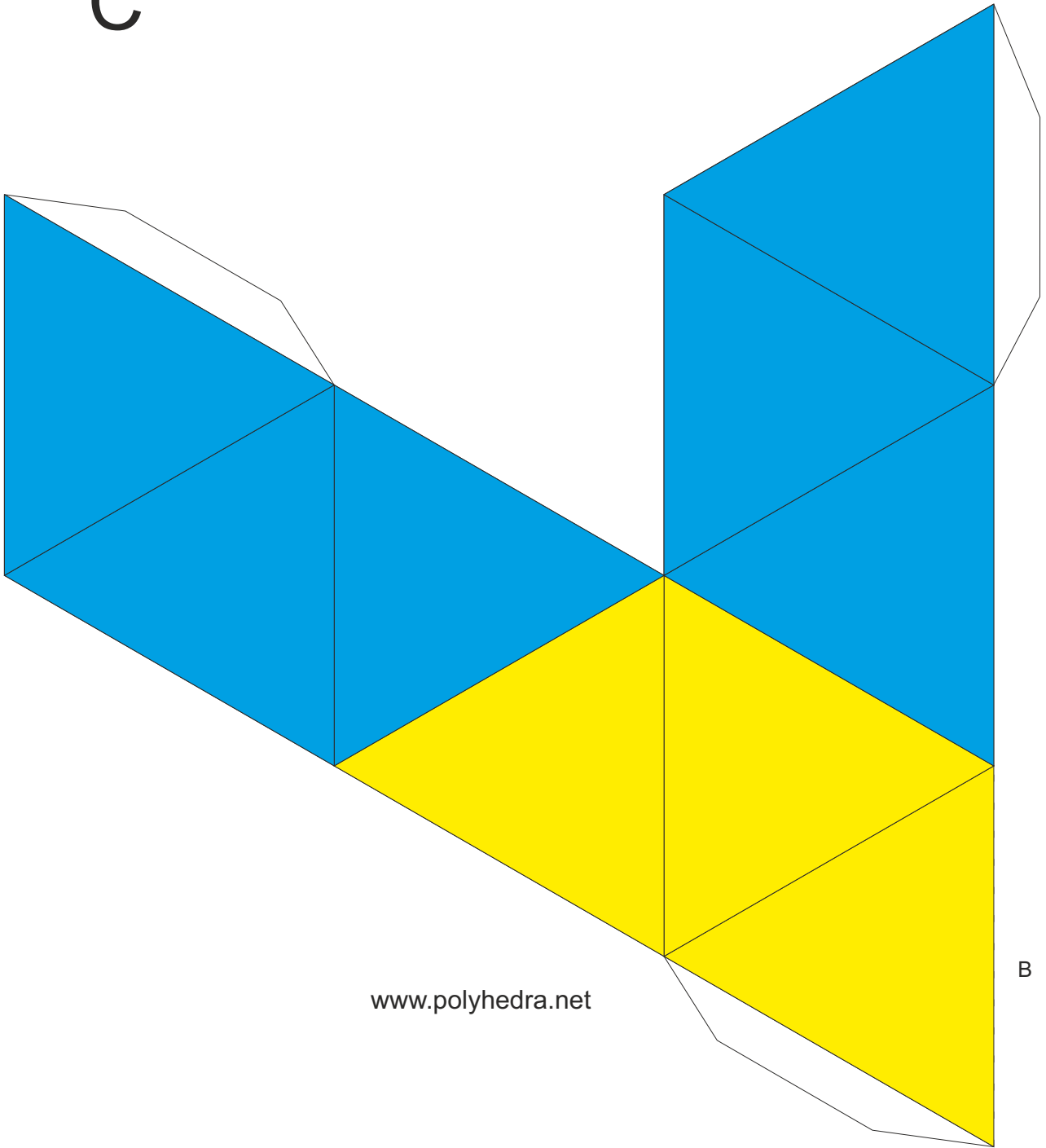

www.polyhedra.net

B

Compound of Cube and Octahedron

Fold the lines between faces of the different colors forward.
Fold the other lines backwards

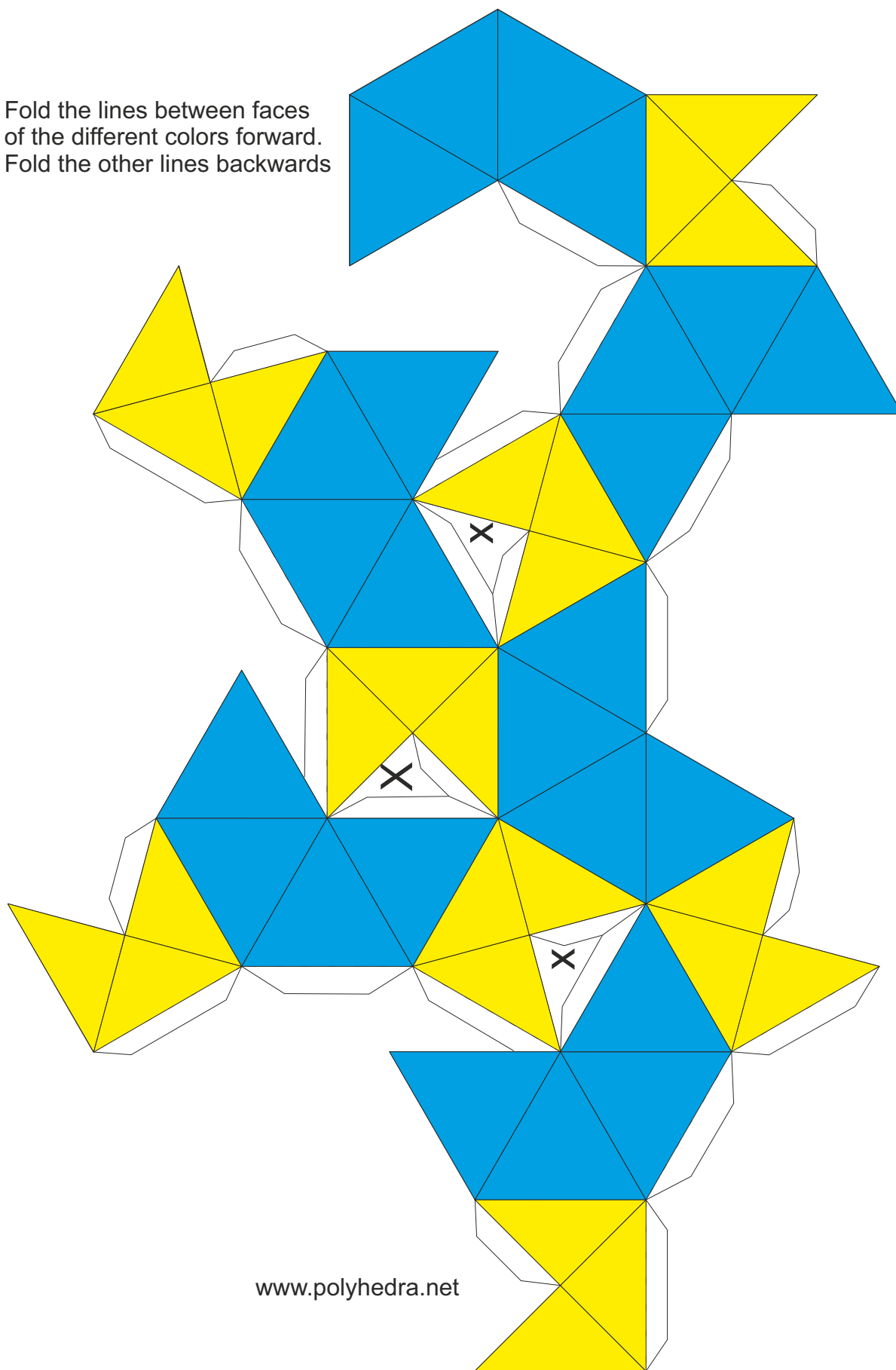

Compound of Cube and Octahedron

Fold the lines between faces of the different colors forward.
Fold the other lines backwards

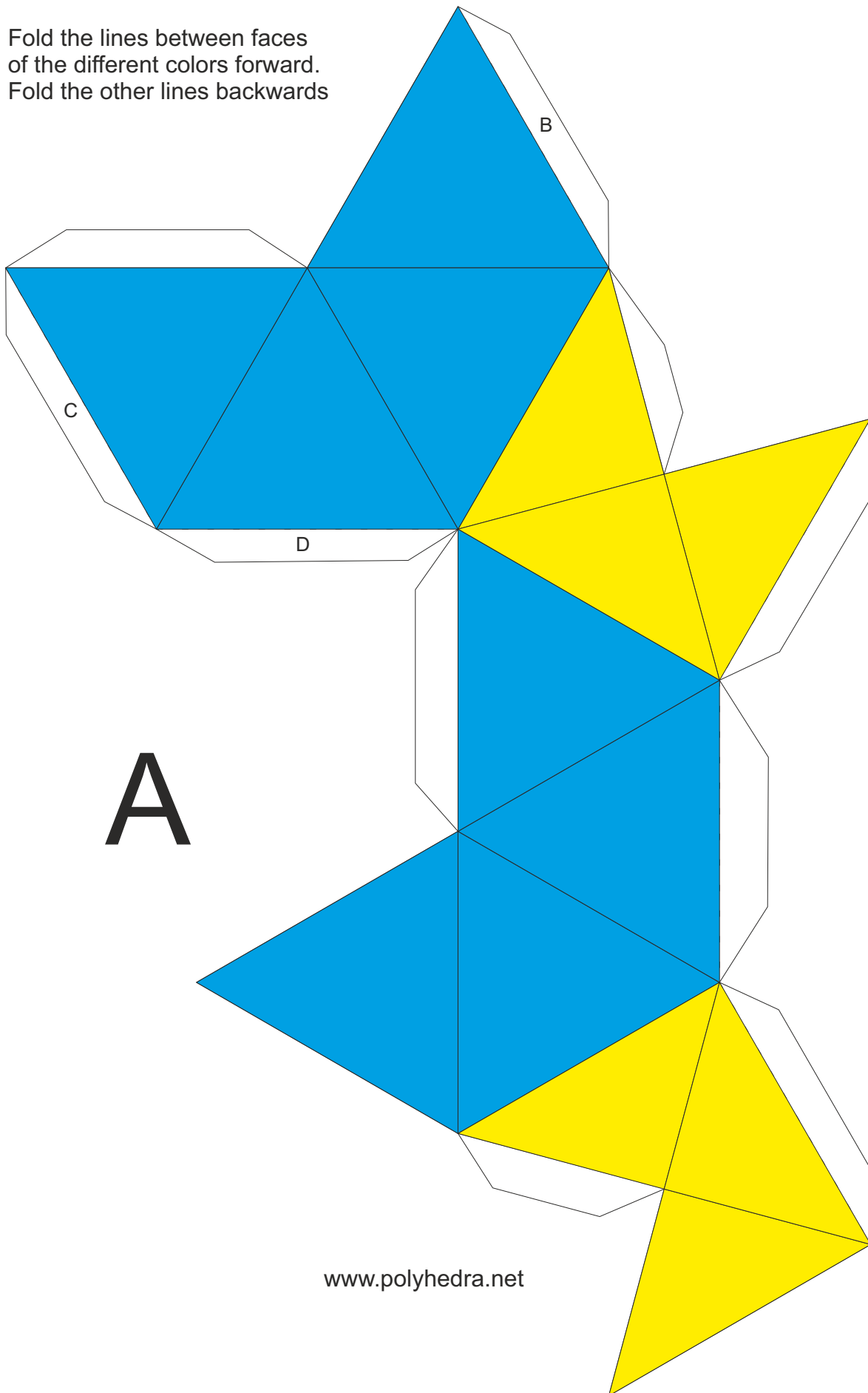

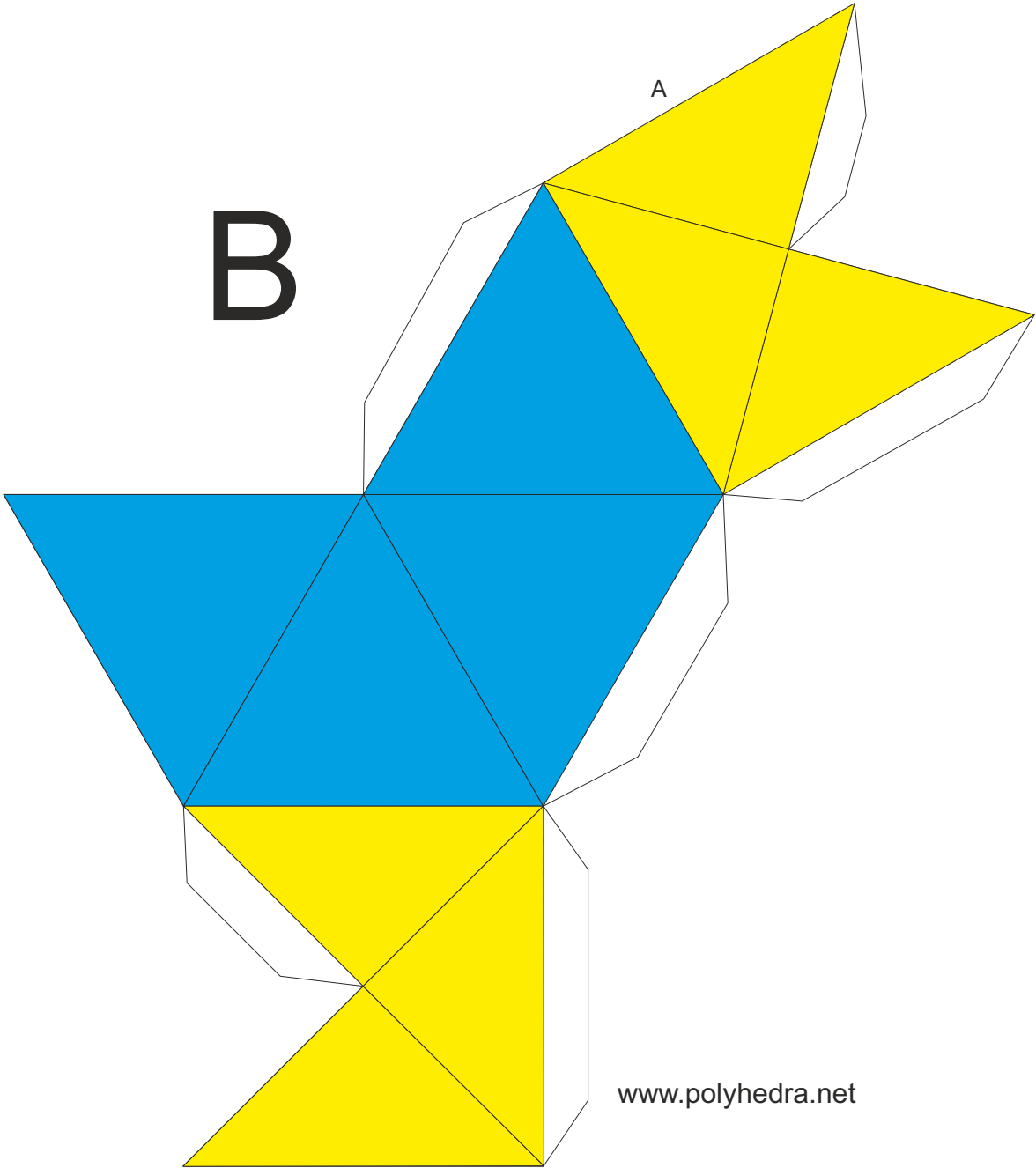

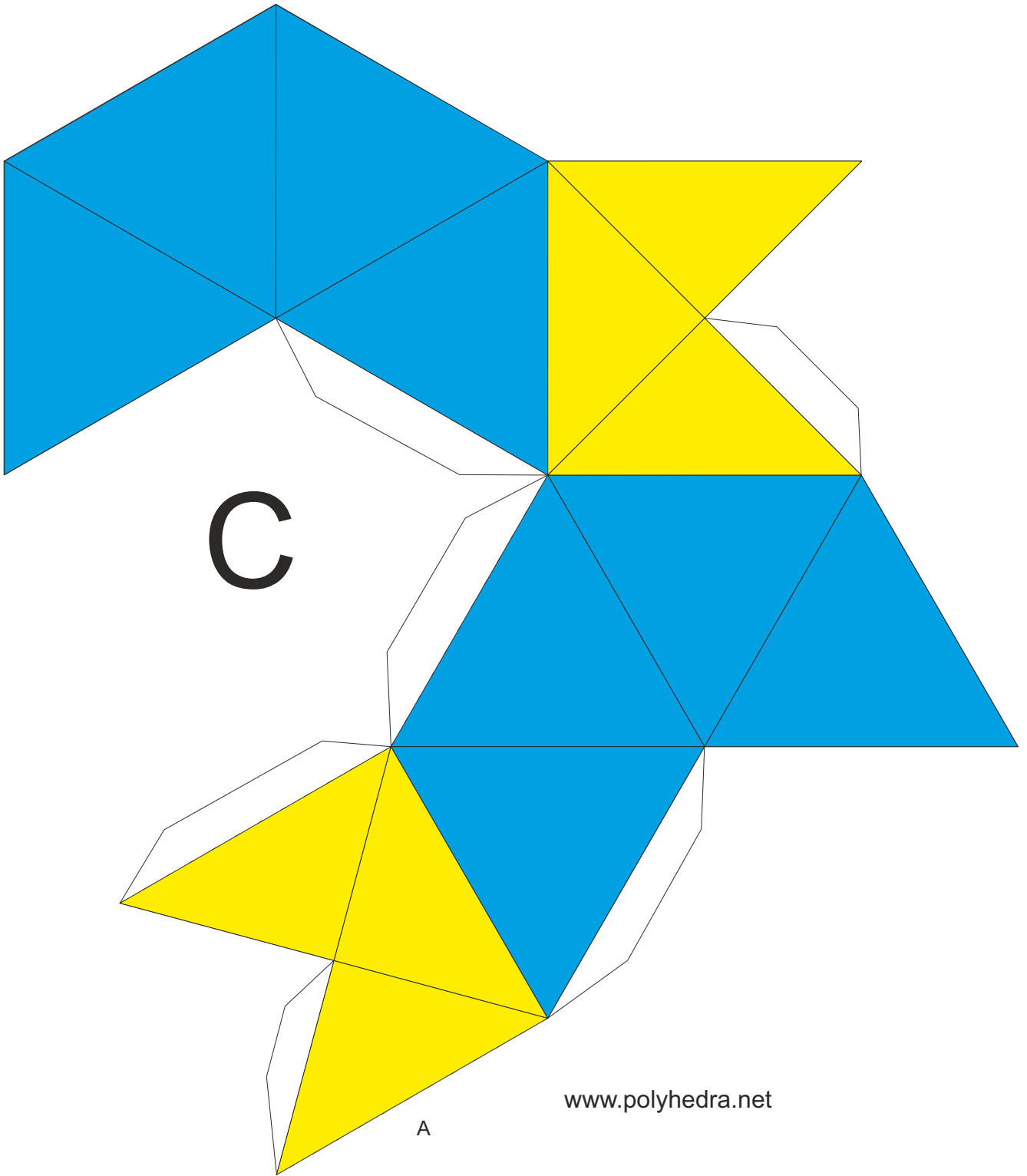

C

A

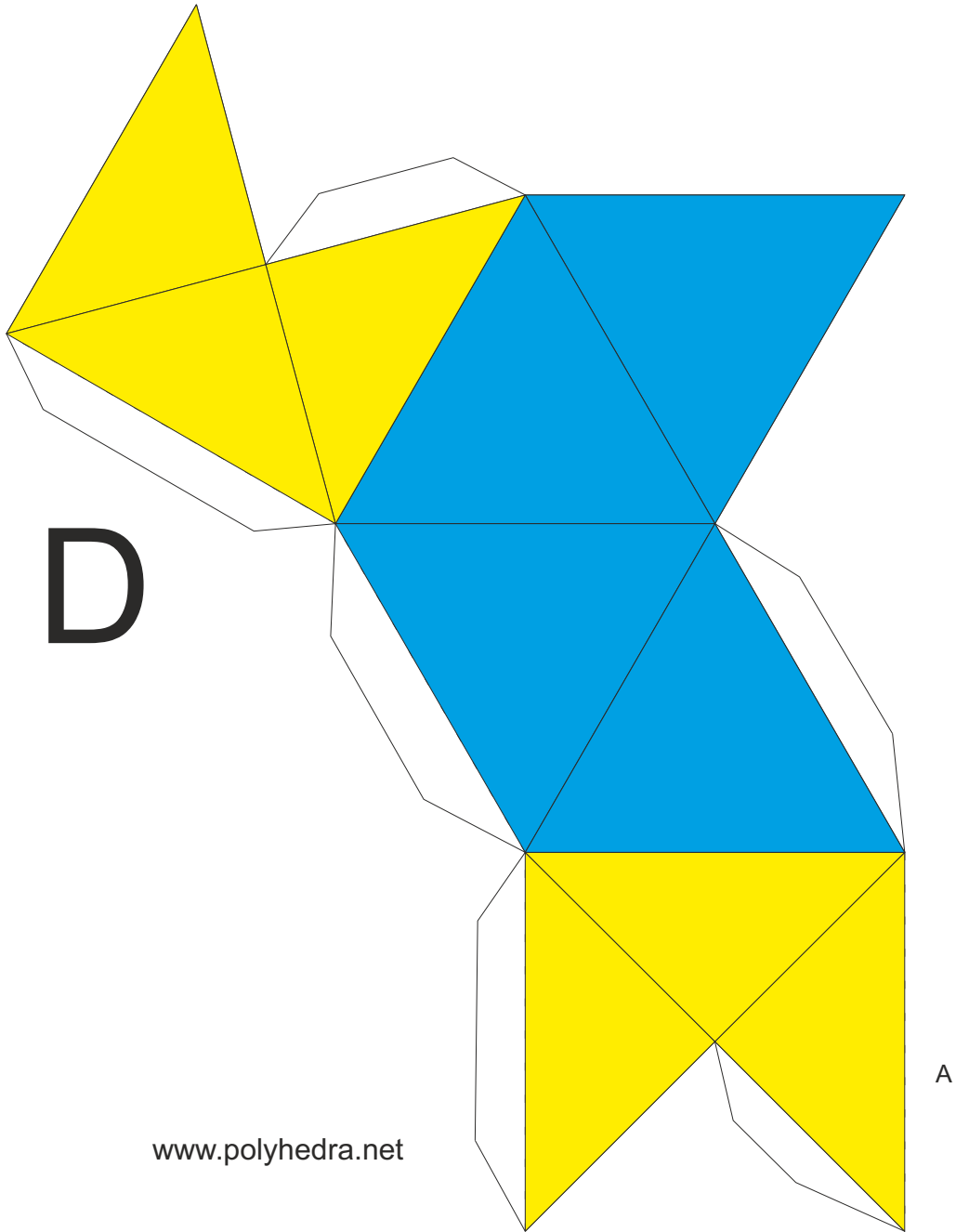

www.polyhedra.net

Compound Dodecahedron and Icosahedron (small version)

Fold the dotted lines forwards
Fold the other lines backwards

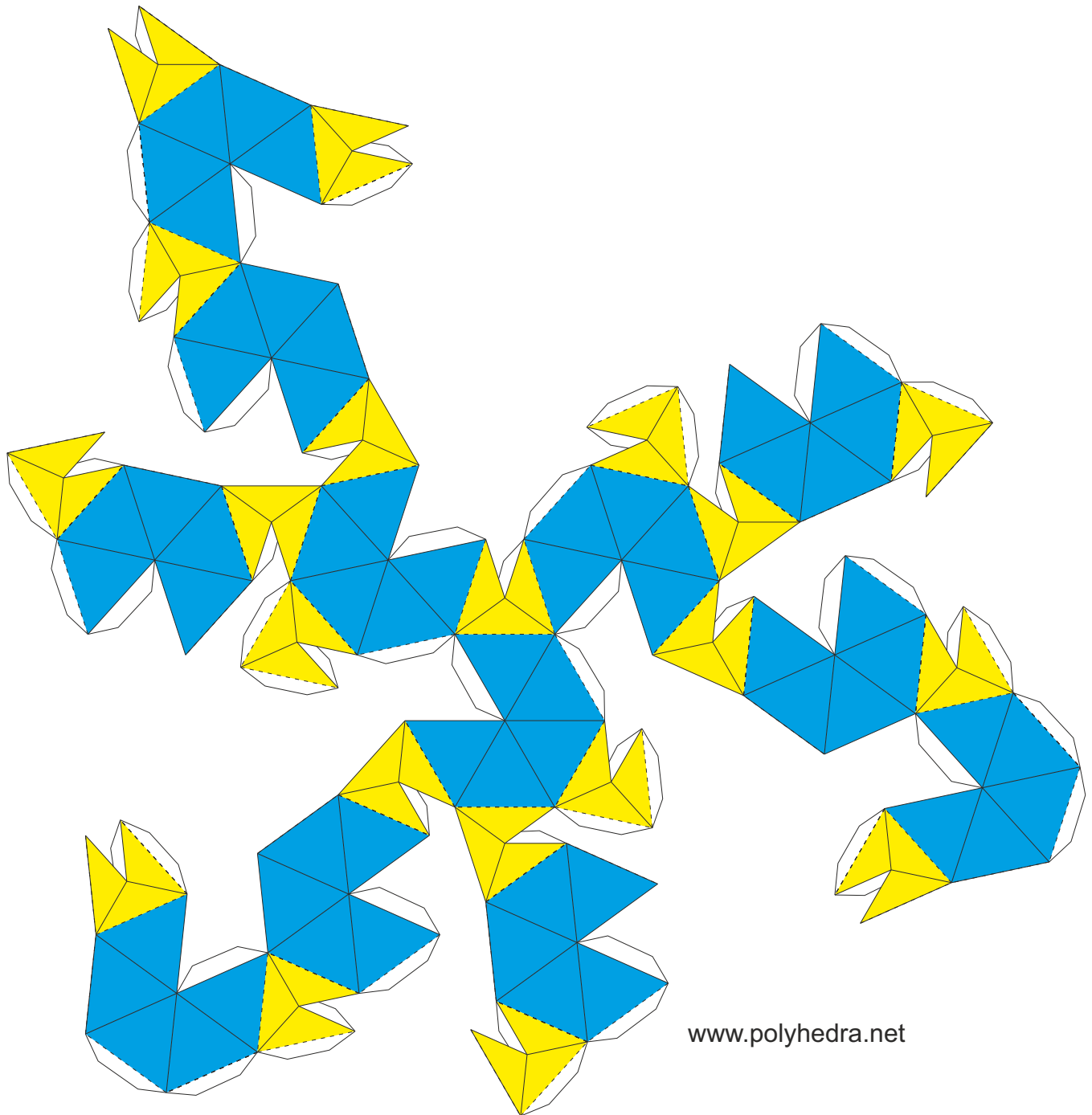

Compound Dodecahedron and Icosahedron (large version made out of three pieces)

Fold the dotted lines forwards
Fold the other lines backwards

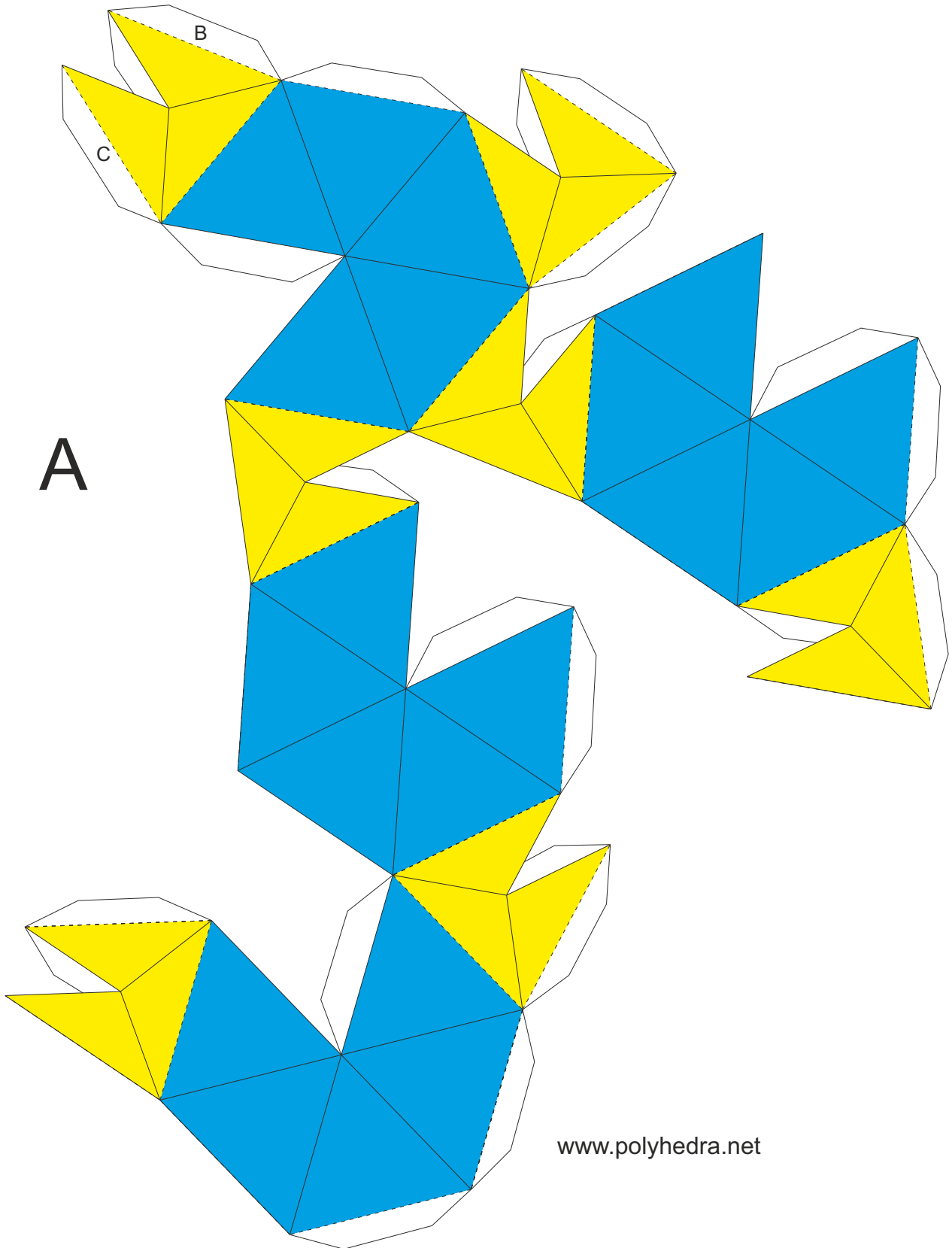

B

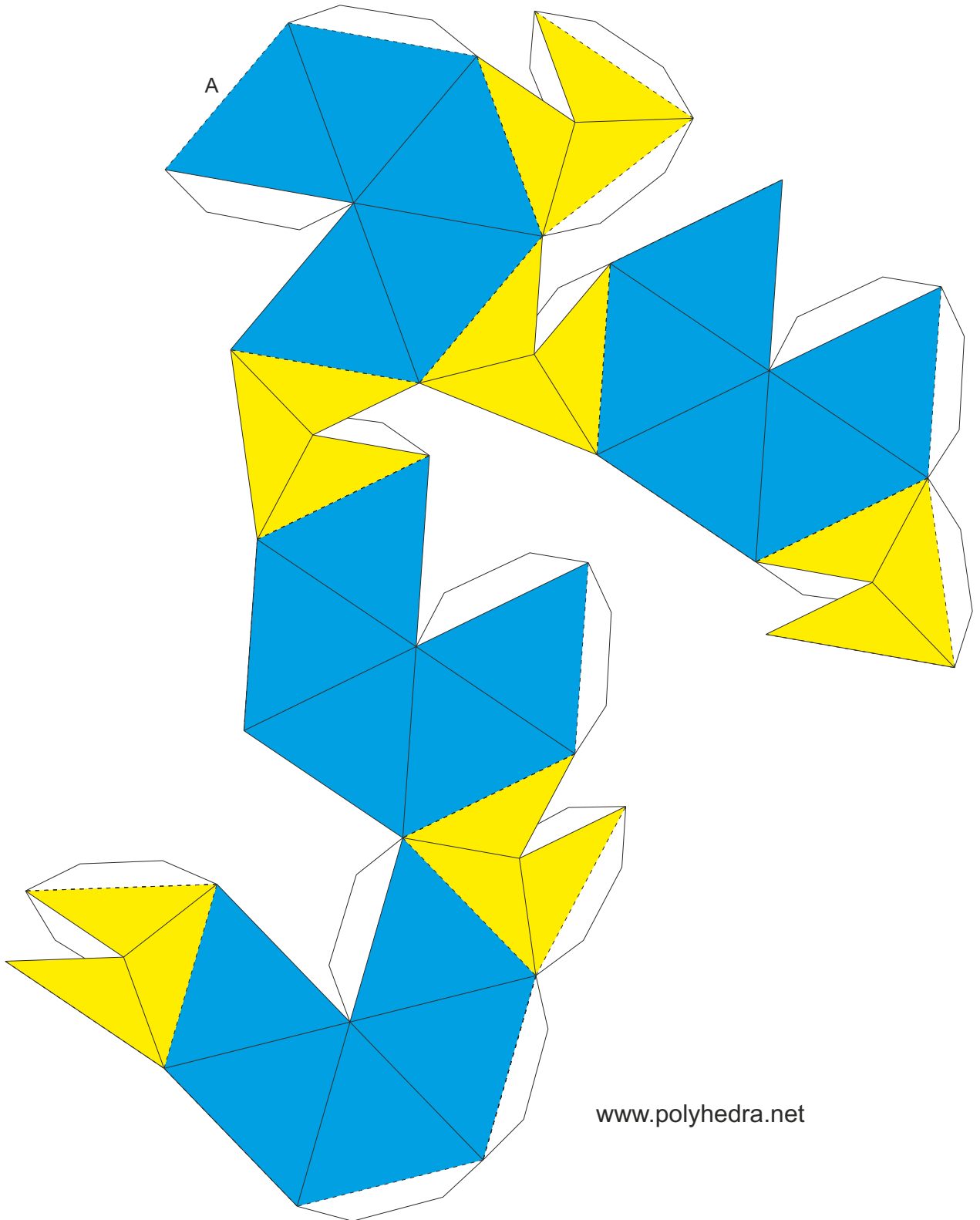

C

