

Small Stellated Dodecahedron

Color 1

Part 1

Use paper in four colors: each color 8 sheets of paper
Fold the dotted lines forwards
Fold the other lines backwards

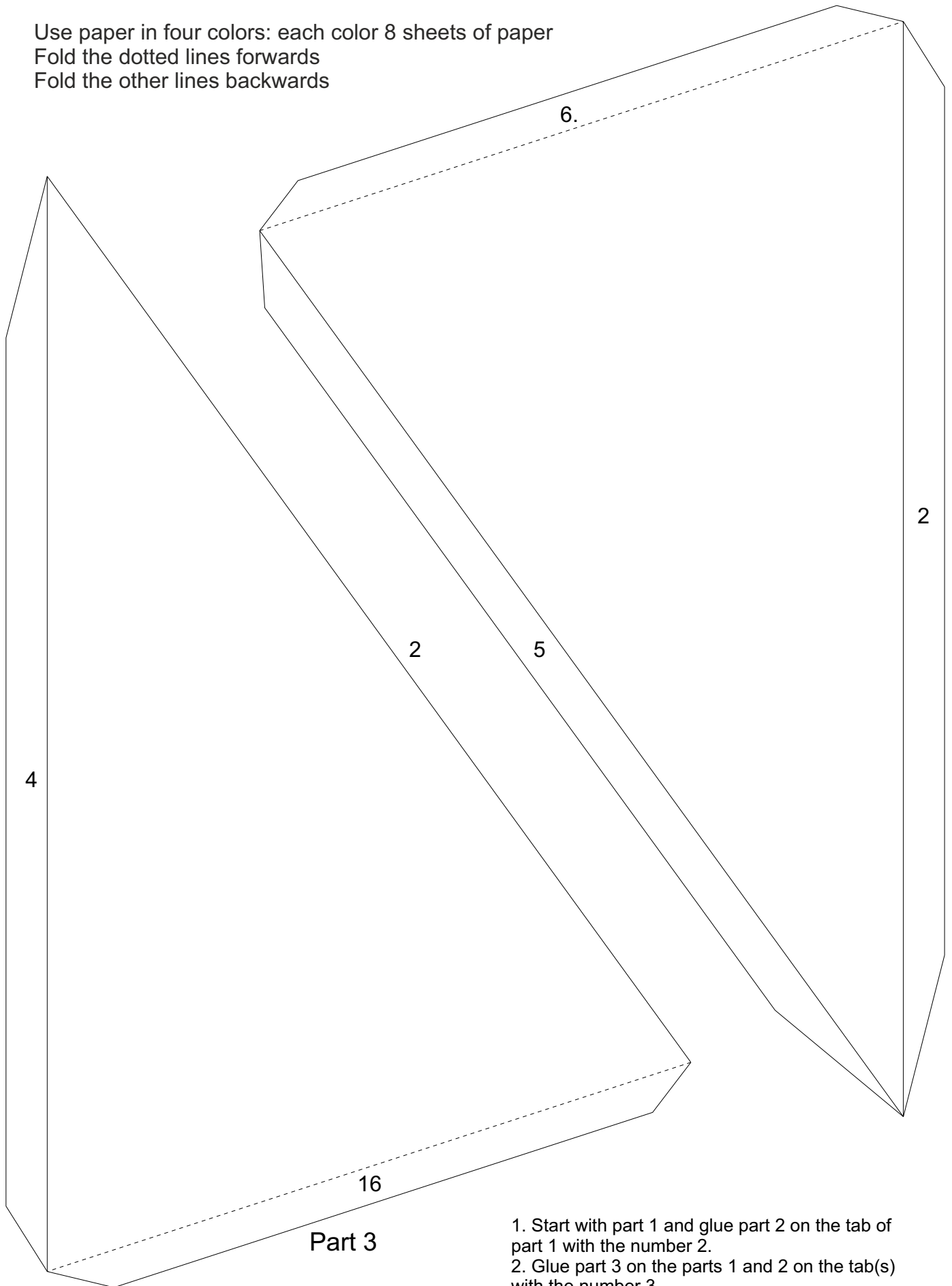

1. Start with part 1 and glue part 2 on the tab of part 1 with the number 2.
 2. Glue part 3 on the parts 1 and 2 on the tab(s) with the number 3.
 3. Glue part 4 on the parts 1, 2 and 3 on the tab(s) with the number 4.
- Etc.

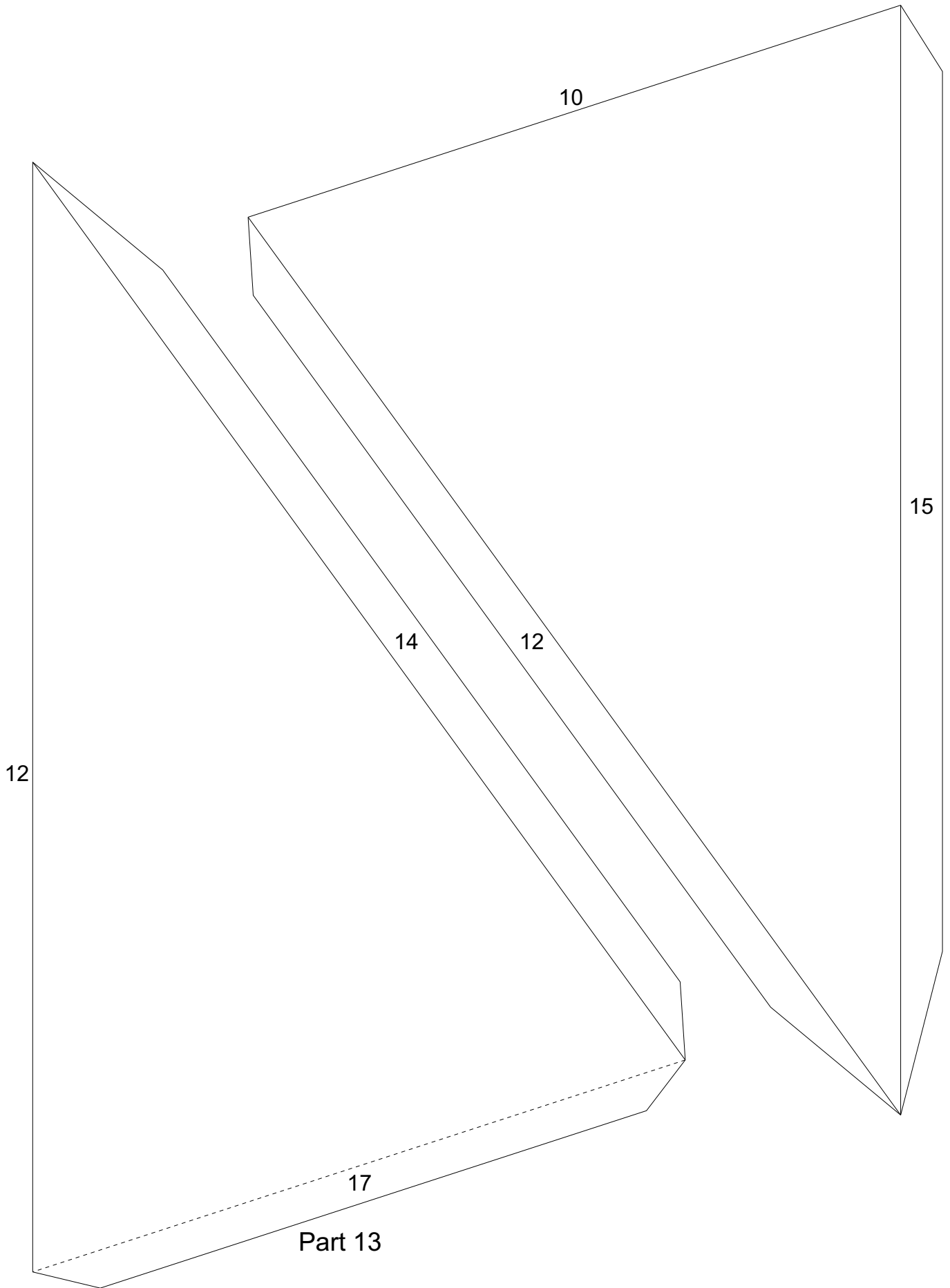

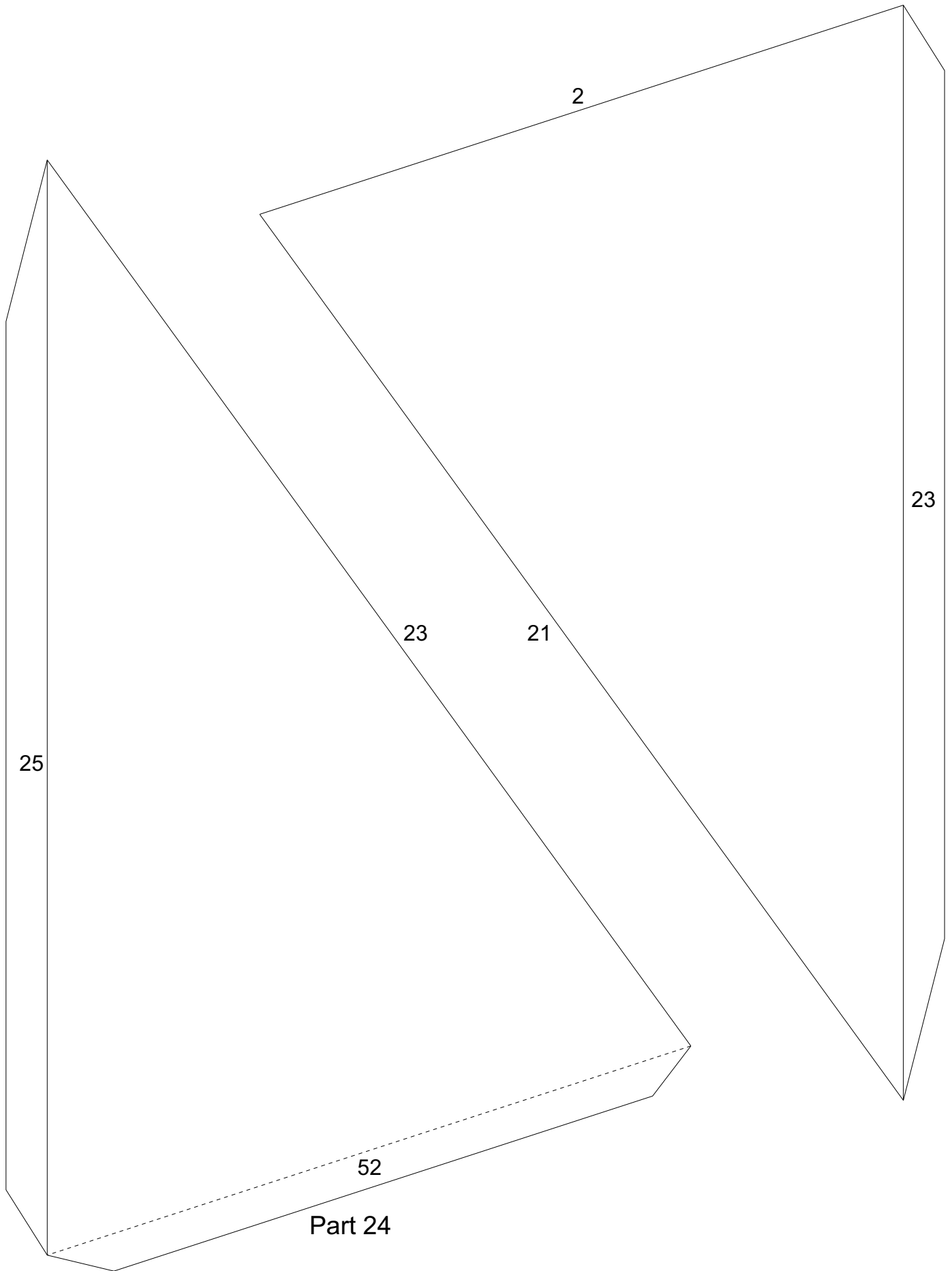

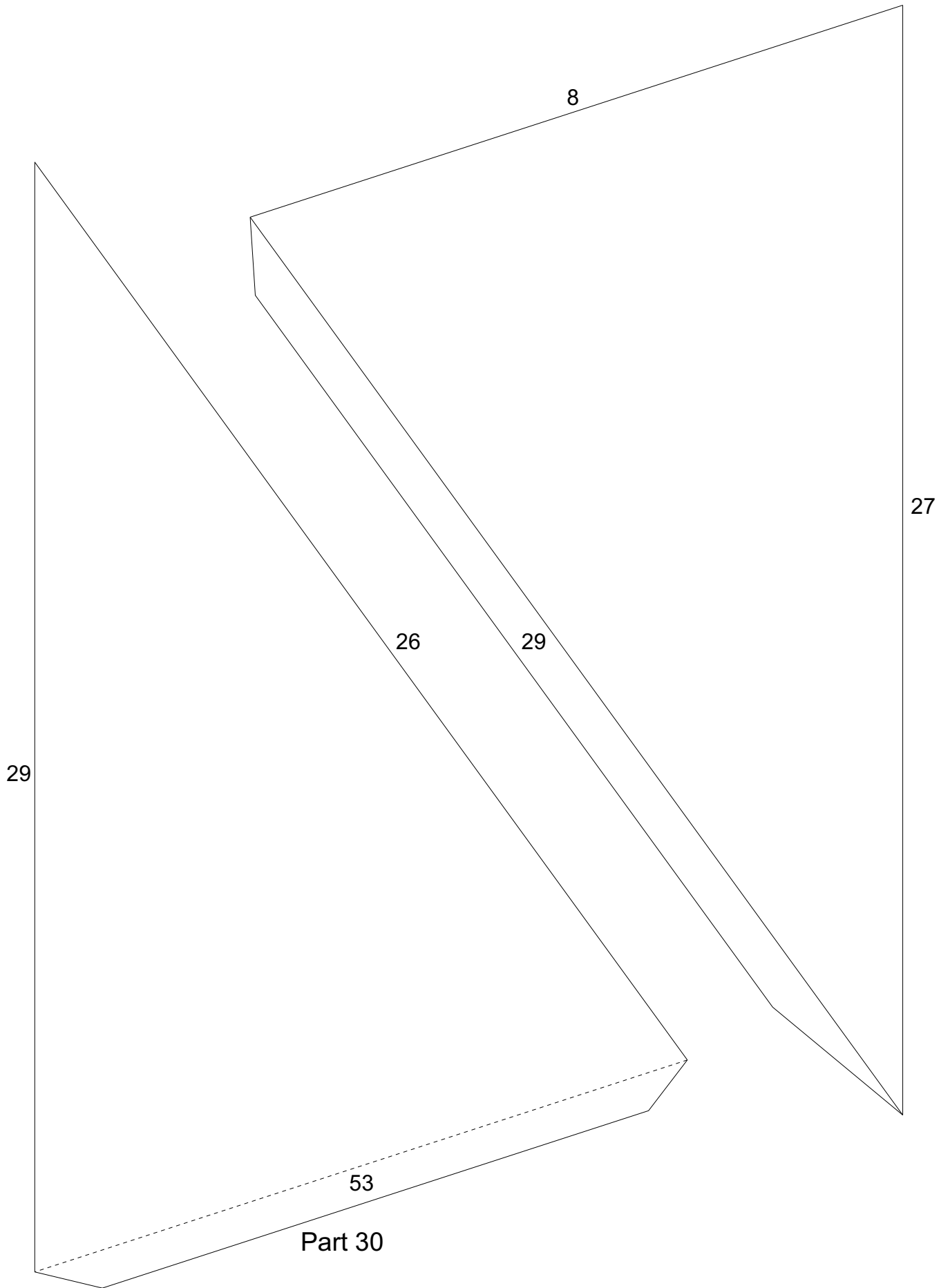

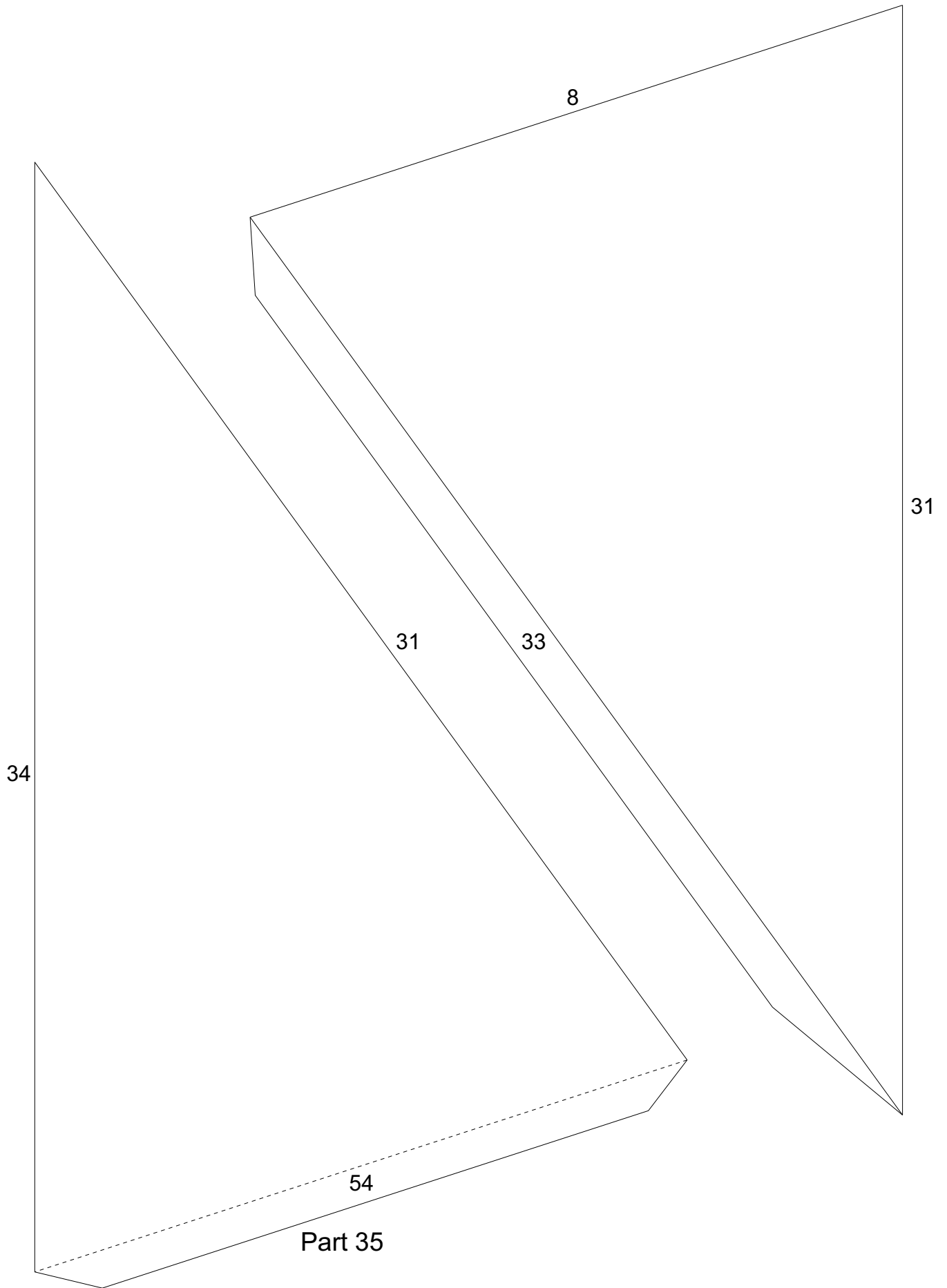

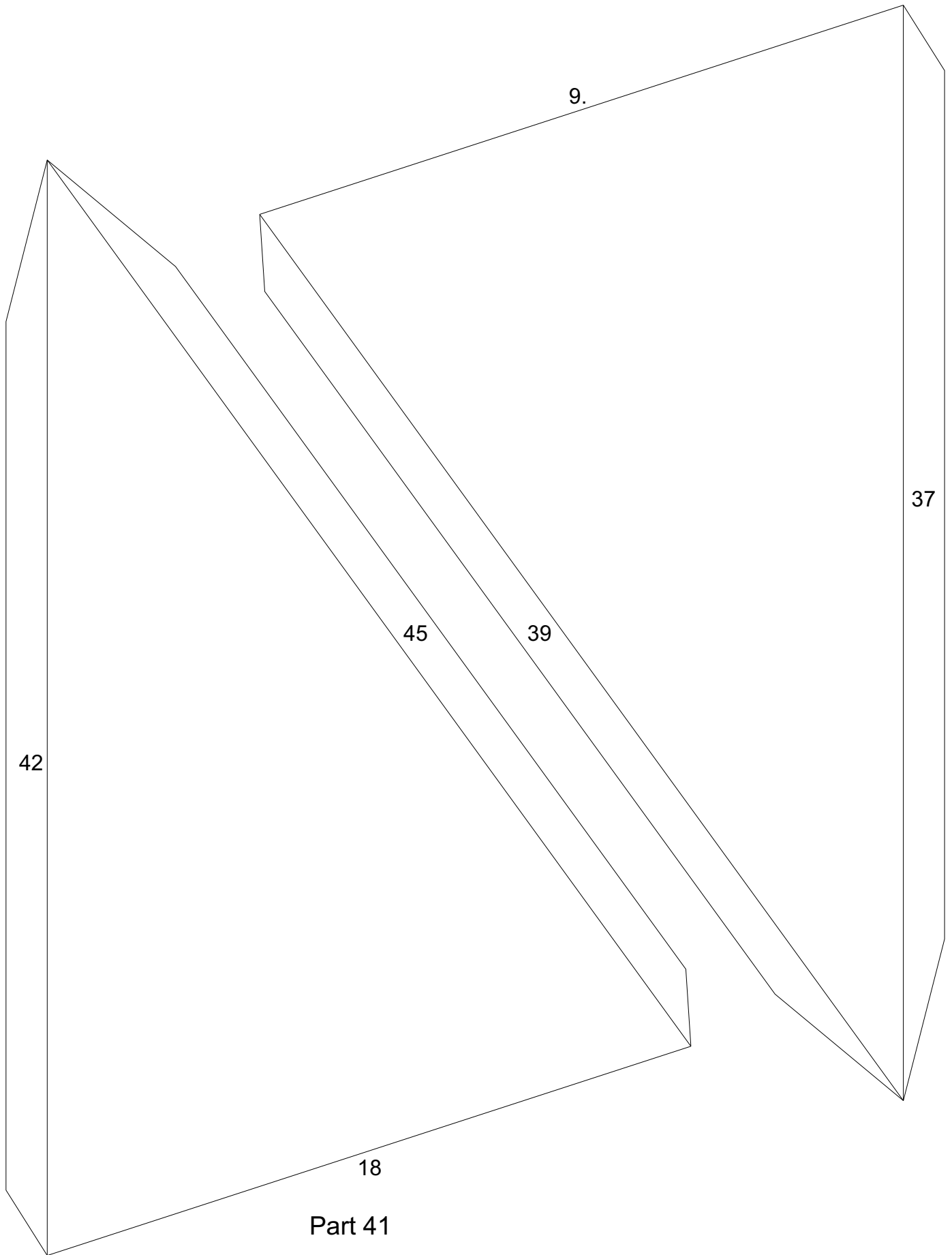

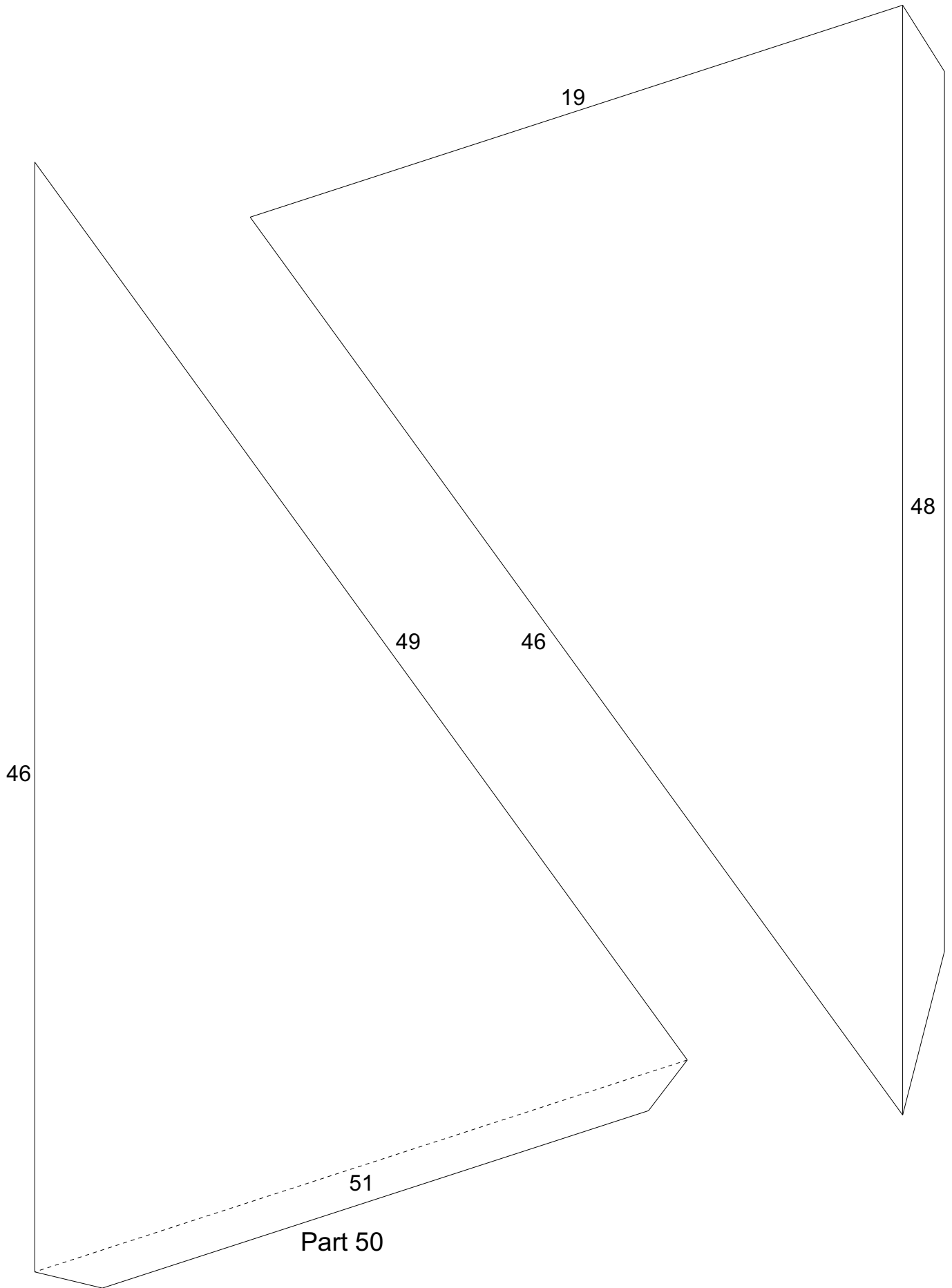

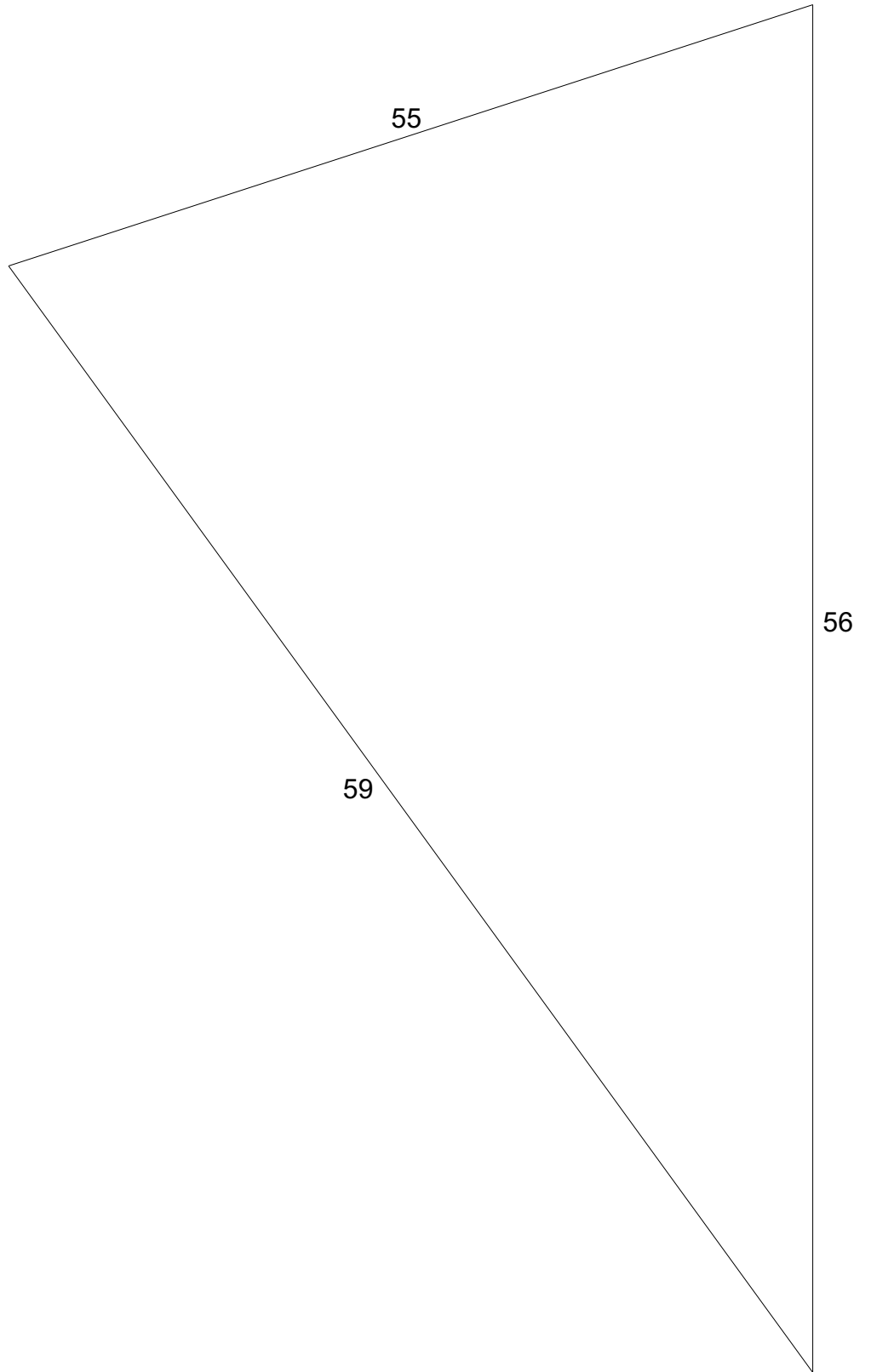

Small Stellated Dodecahedron

Color 2

Part 2

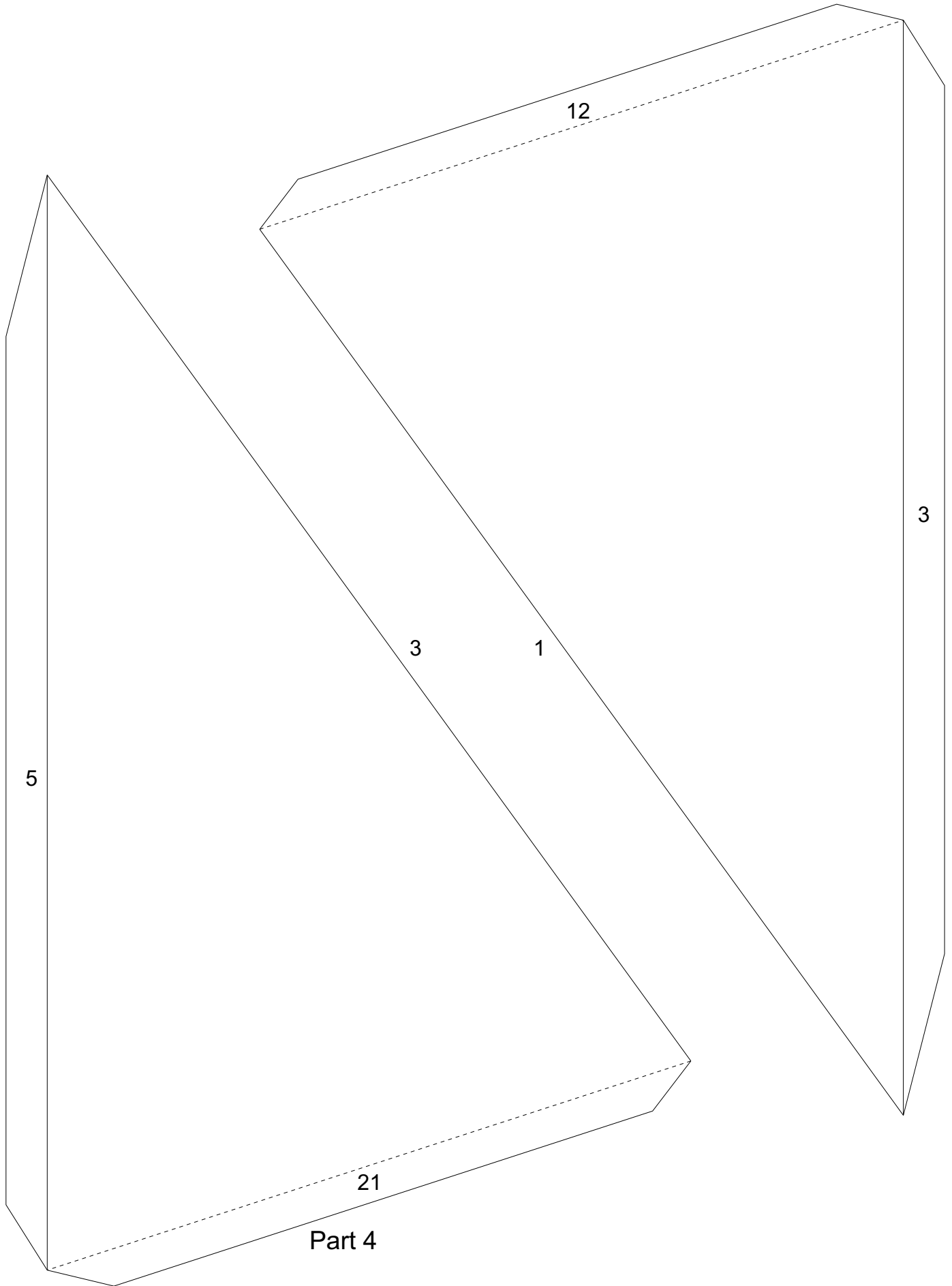

Small Stellated Dodecahedron

Color 2

Part 10

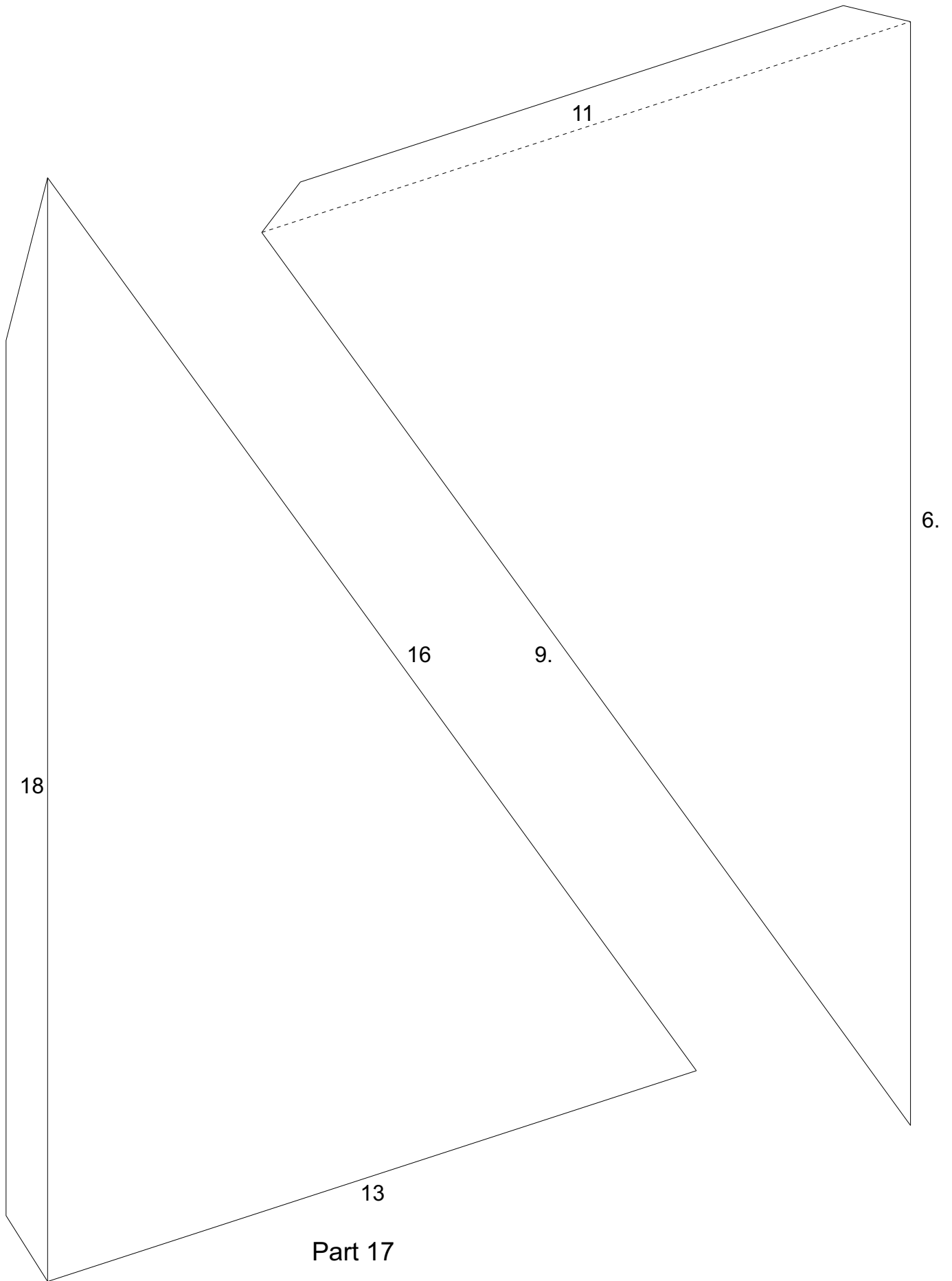

Small Stellated Dodecahedron

Color 2

Part 20

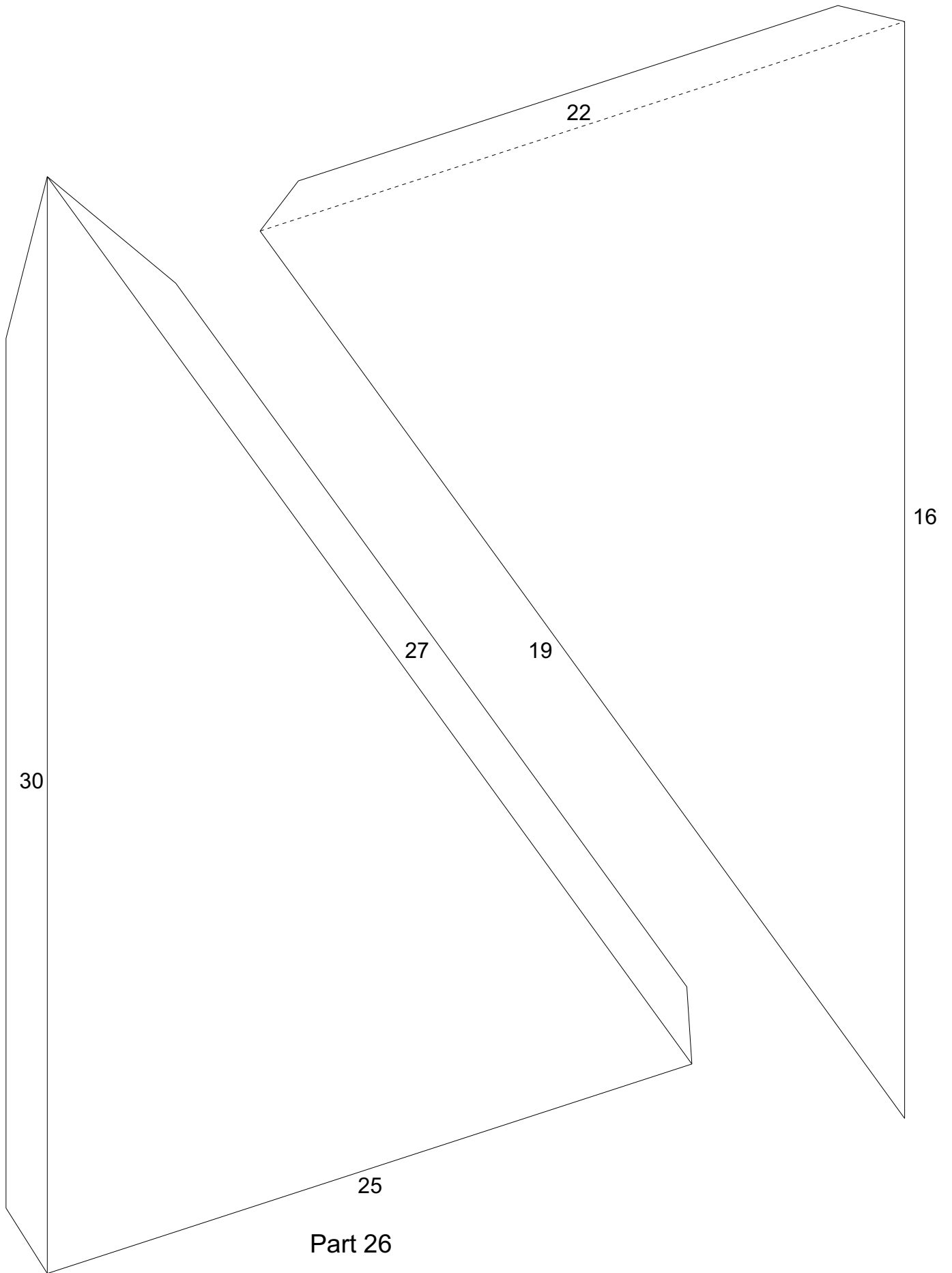

Small Stellated Dodecahedron

Color 2

Part 34

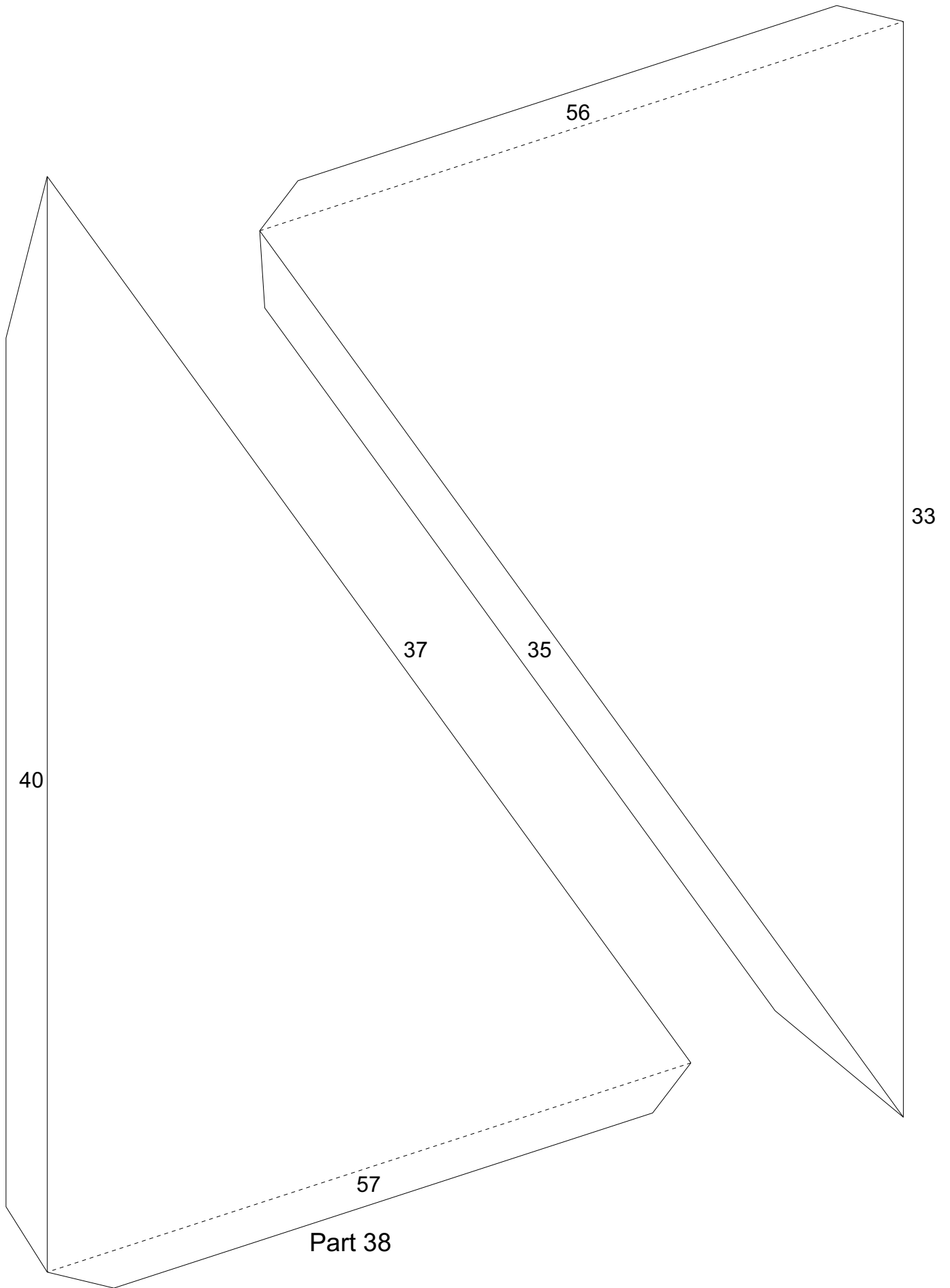

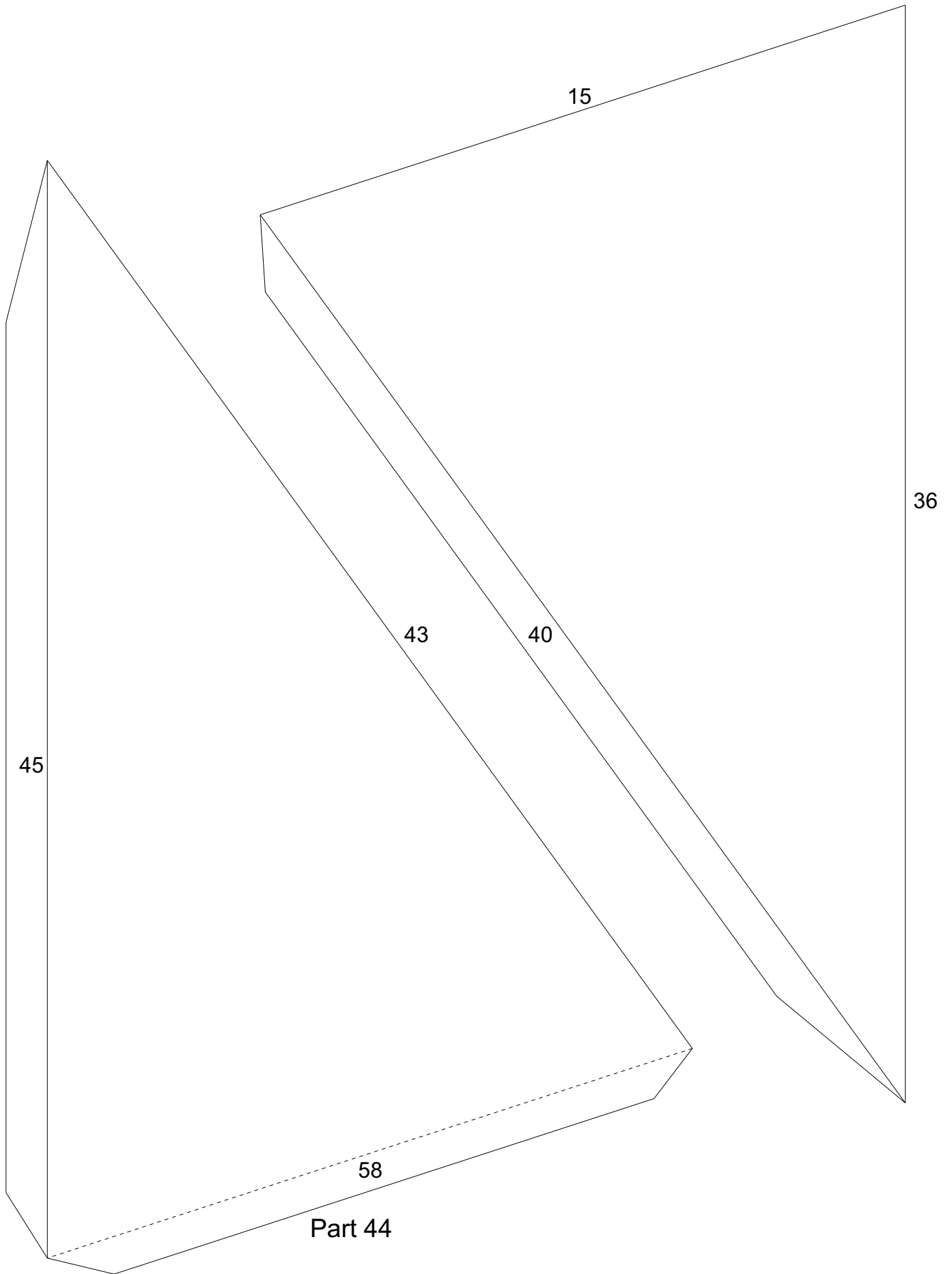

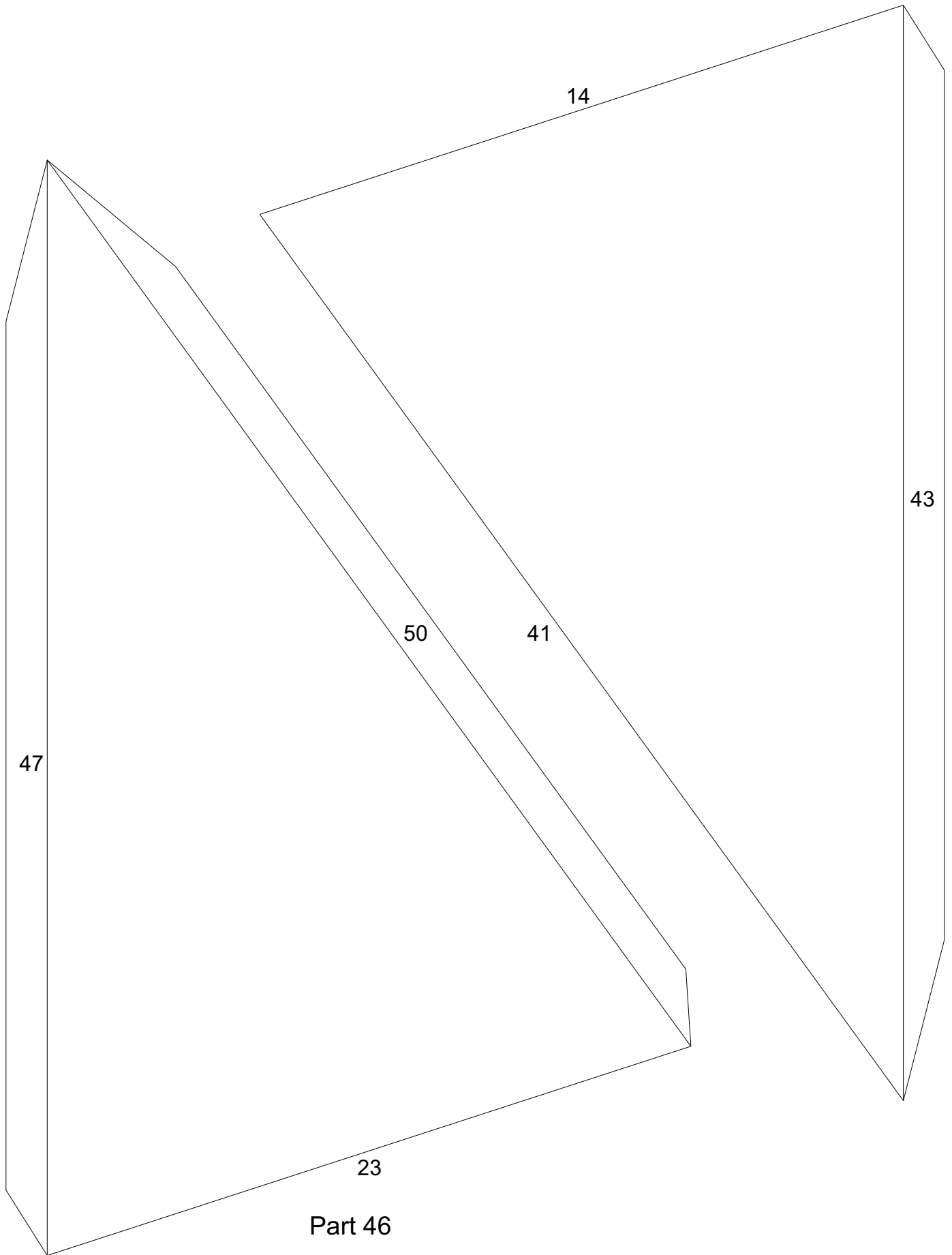

Small Stellated Dodecahedron

Color 2

Part 49

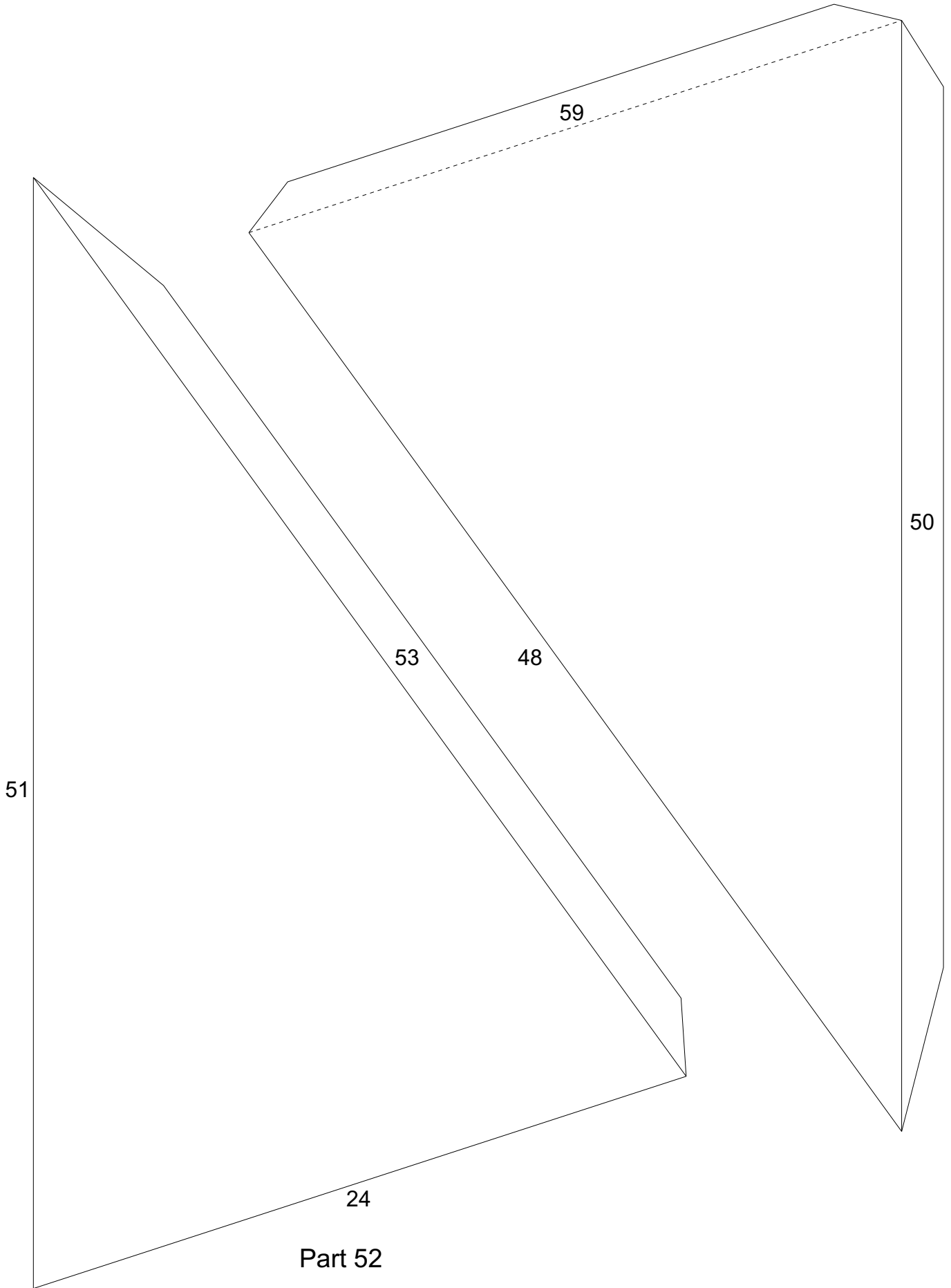

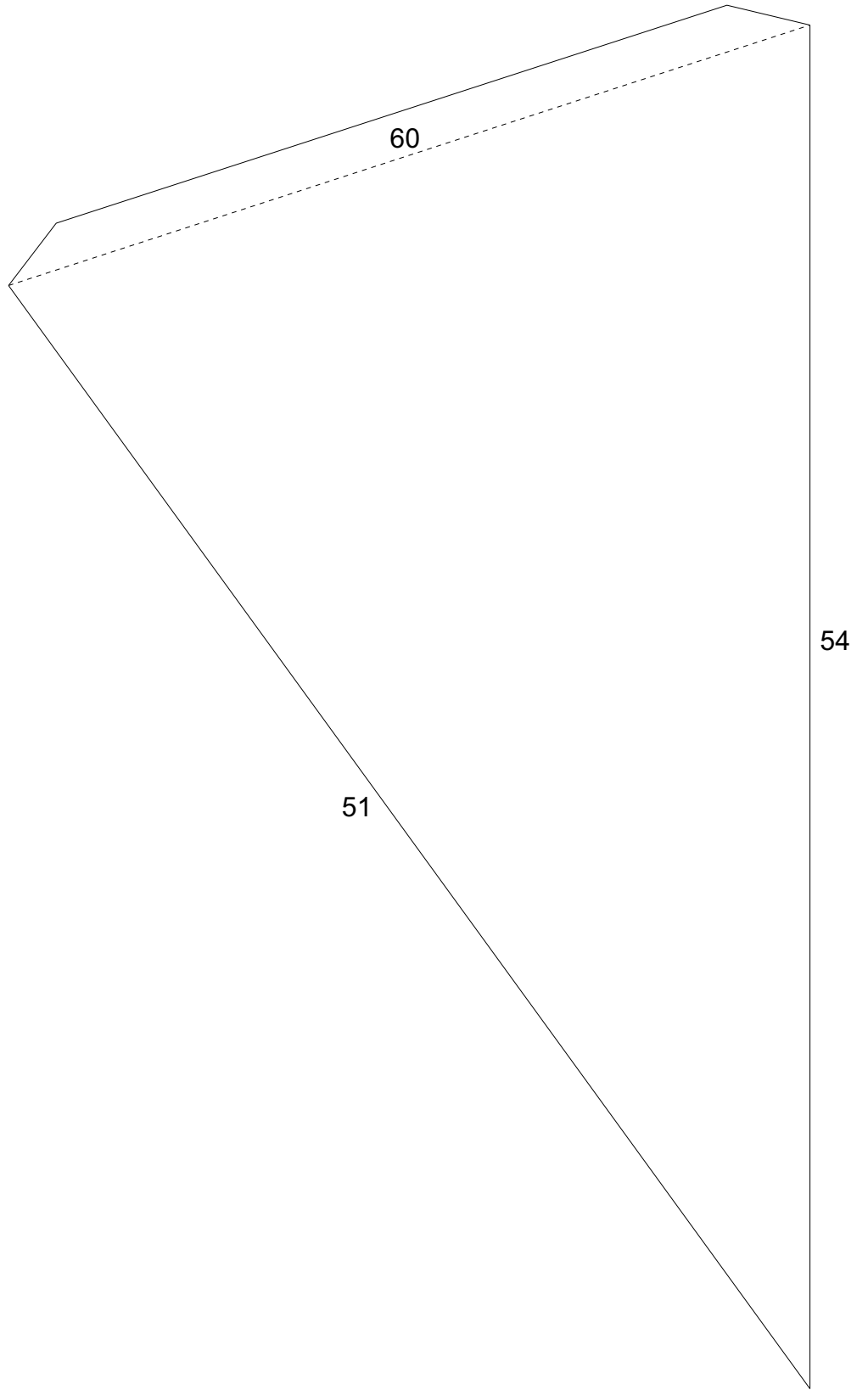

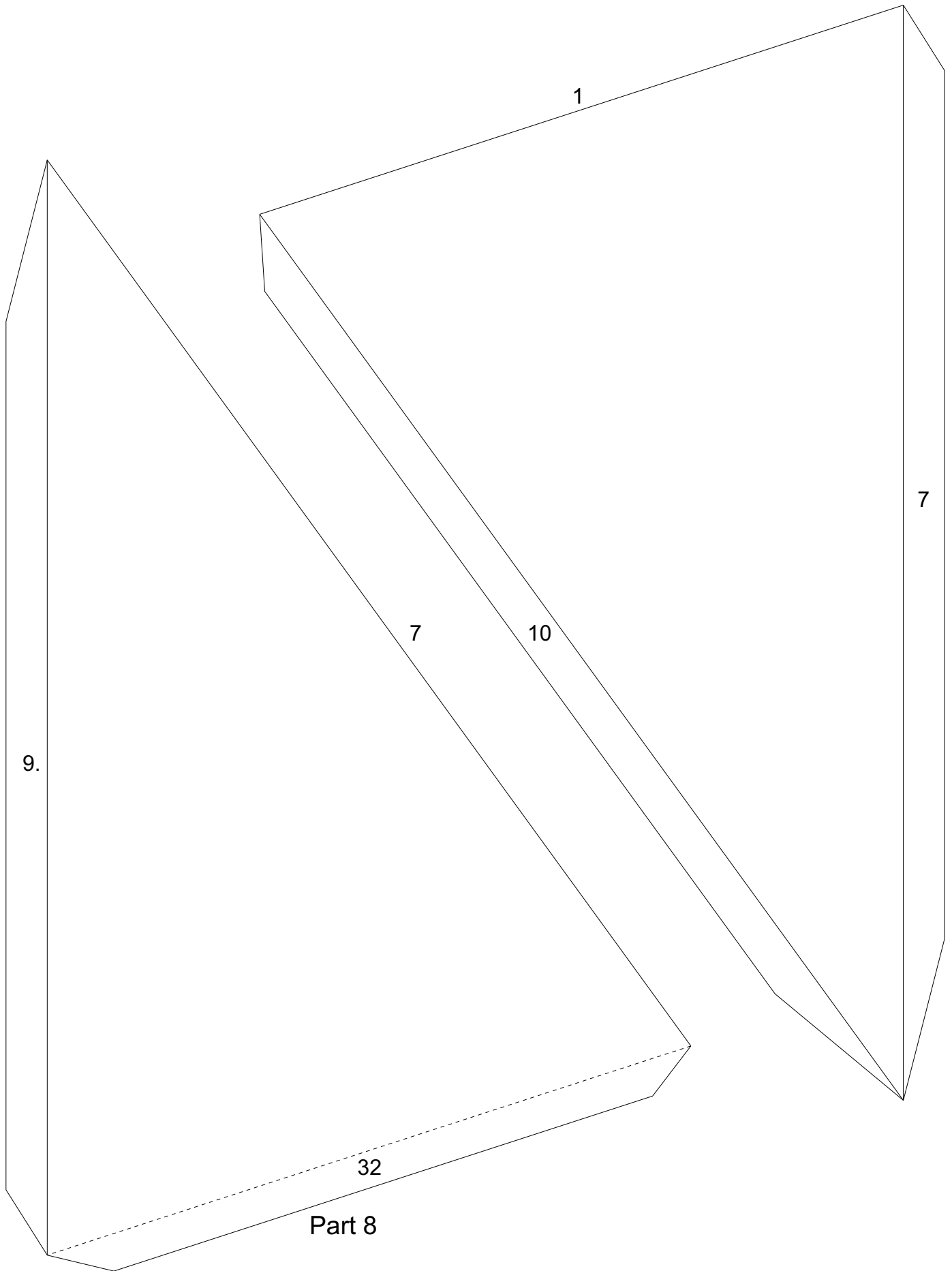

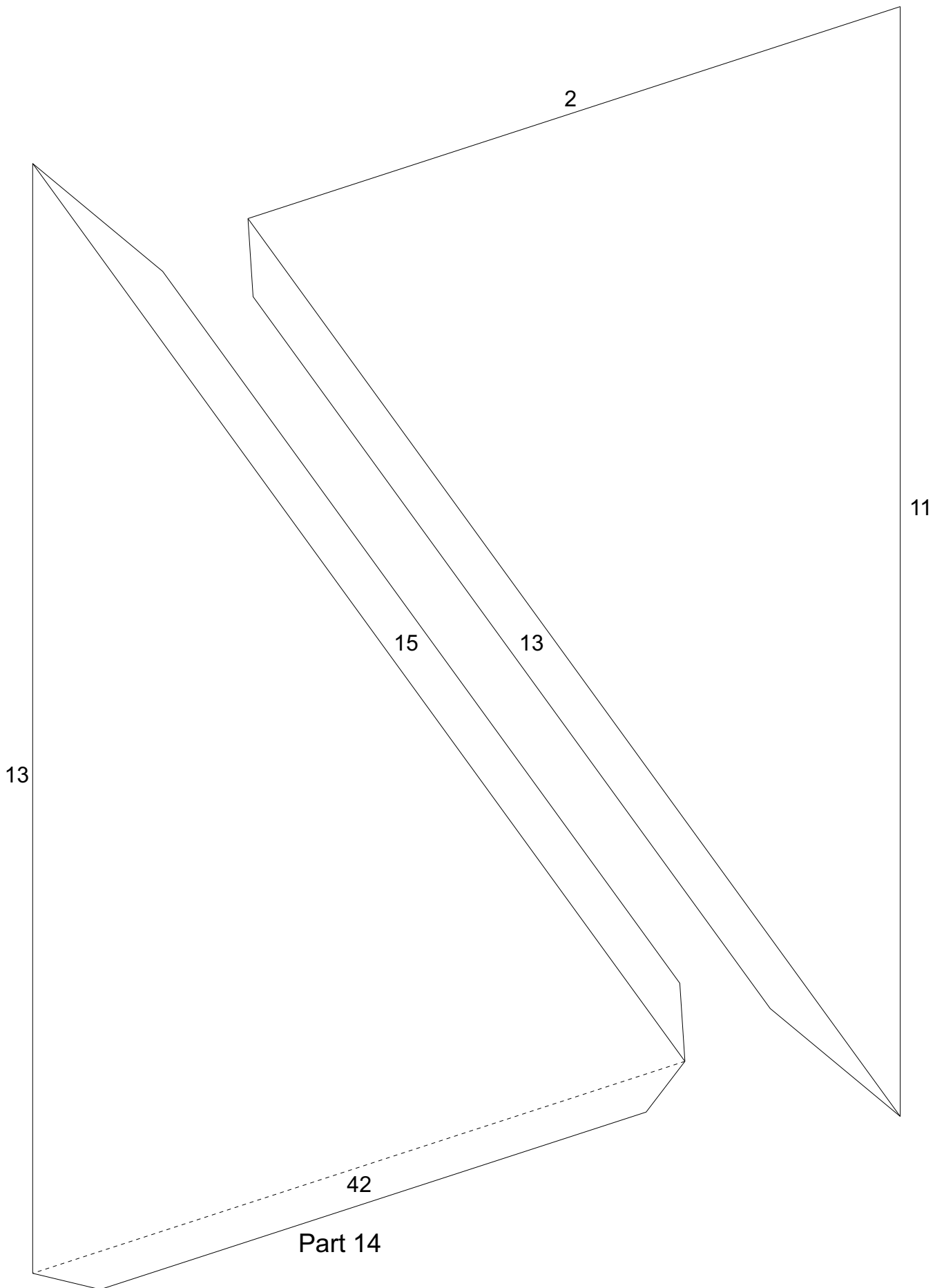

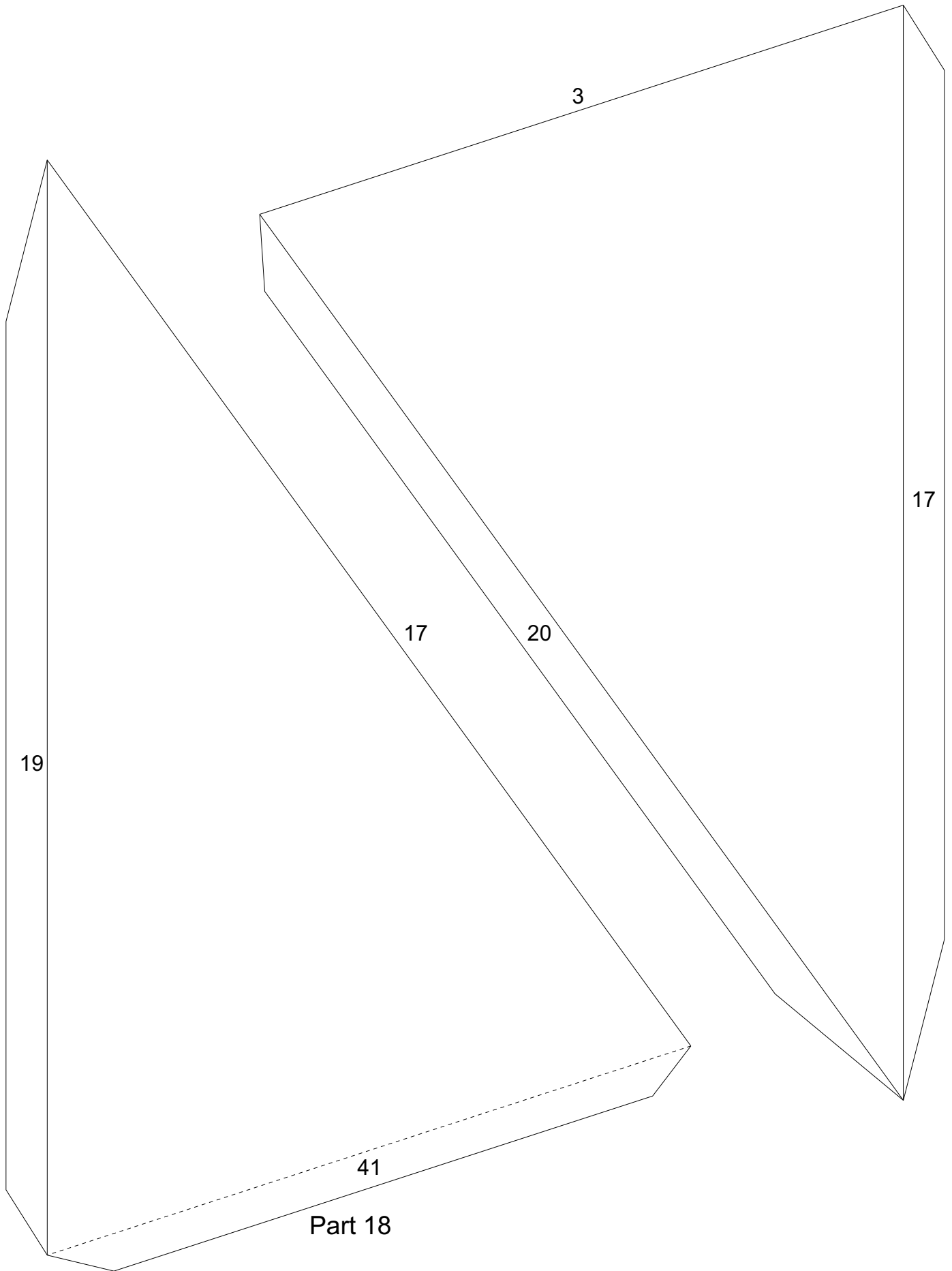

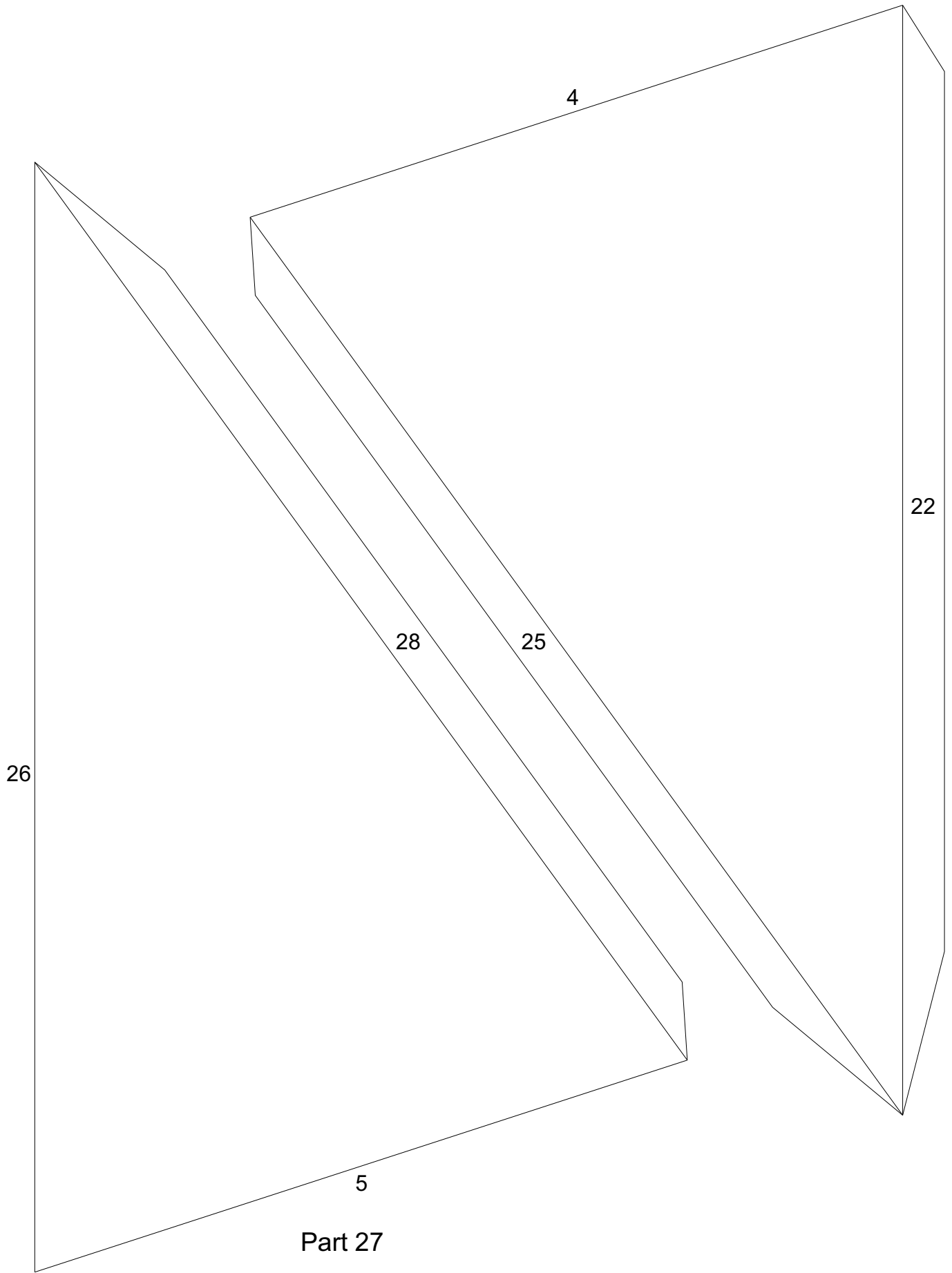

Small Stellated Dodecahedron

Color 3

Part 29

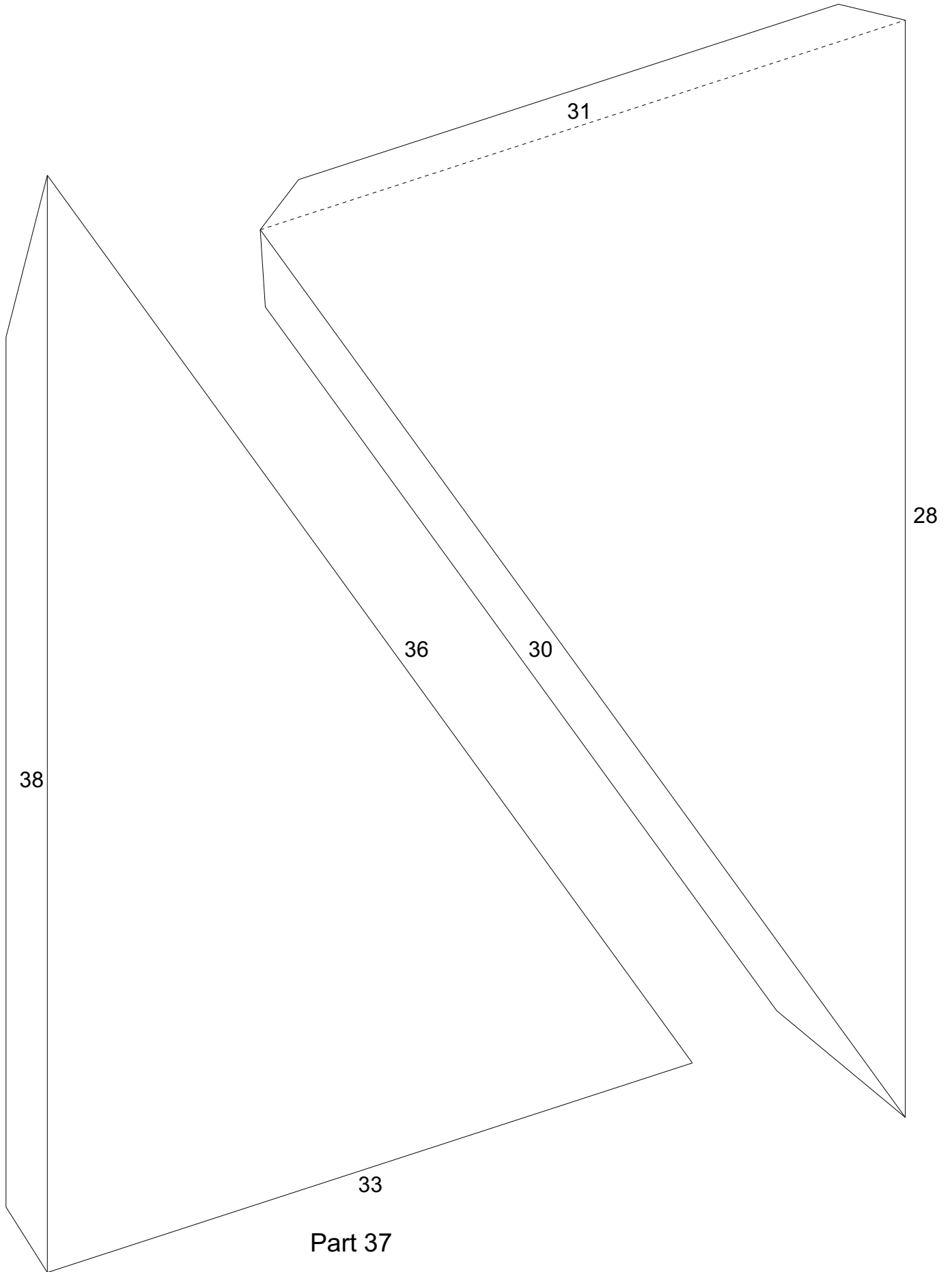

Small Stellated Dodecahedron

Color 3

Part 40

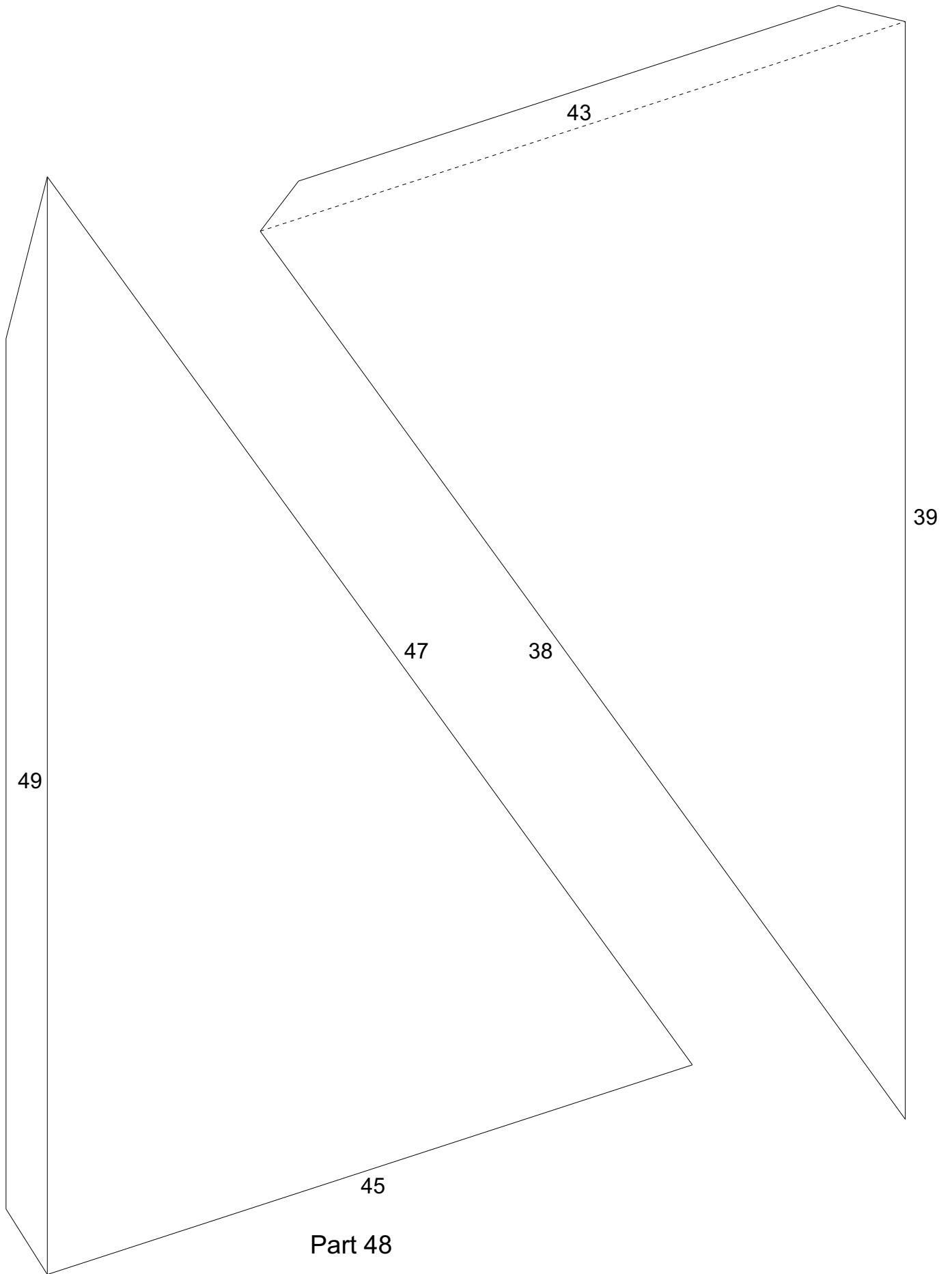

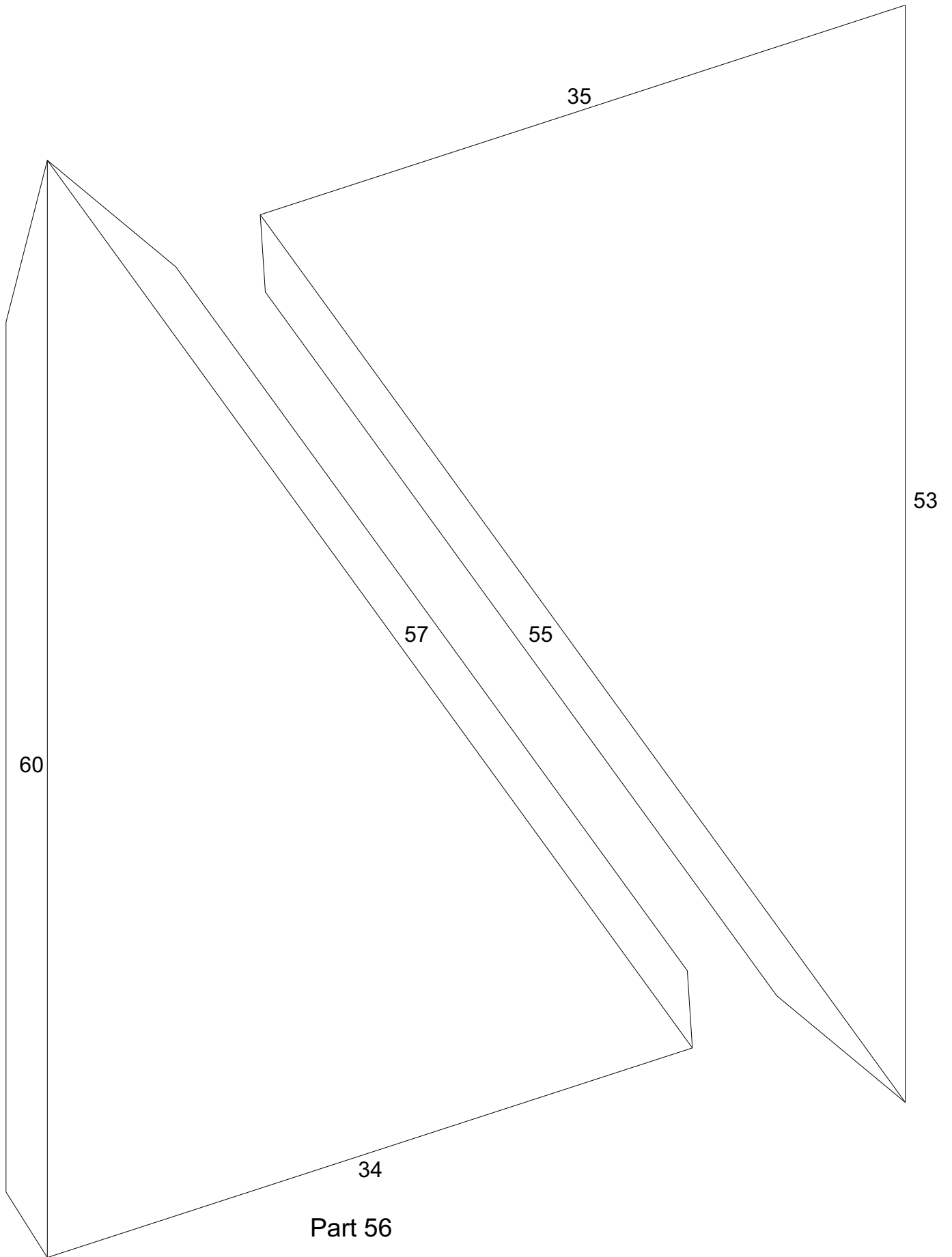

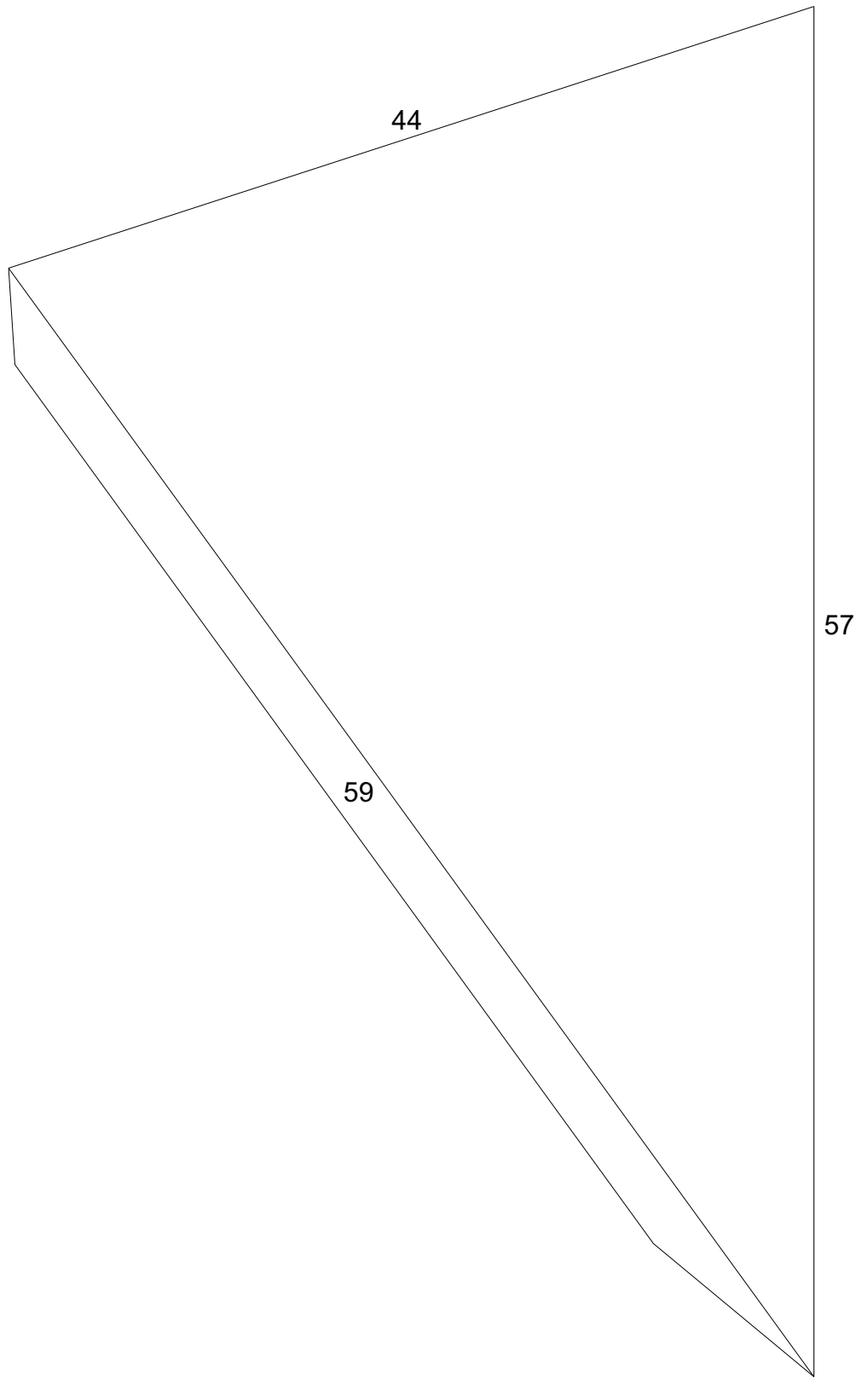

Small Stellated Dodecahedron

Color 4

Part 5

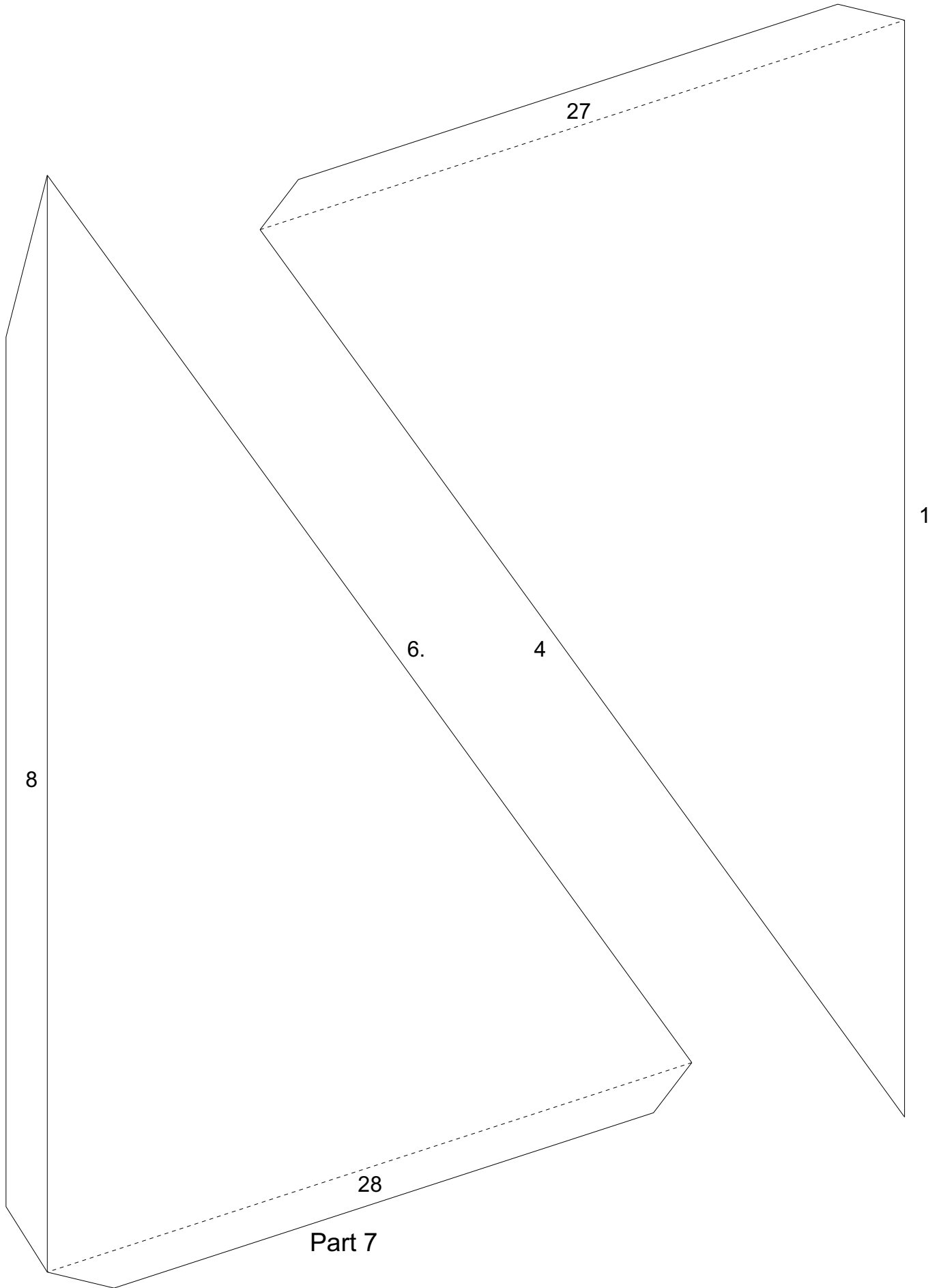

Small Stellated Dodecahedron

Color 4

Part 9.

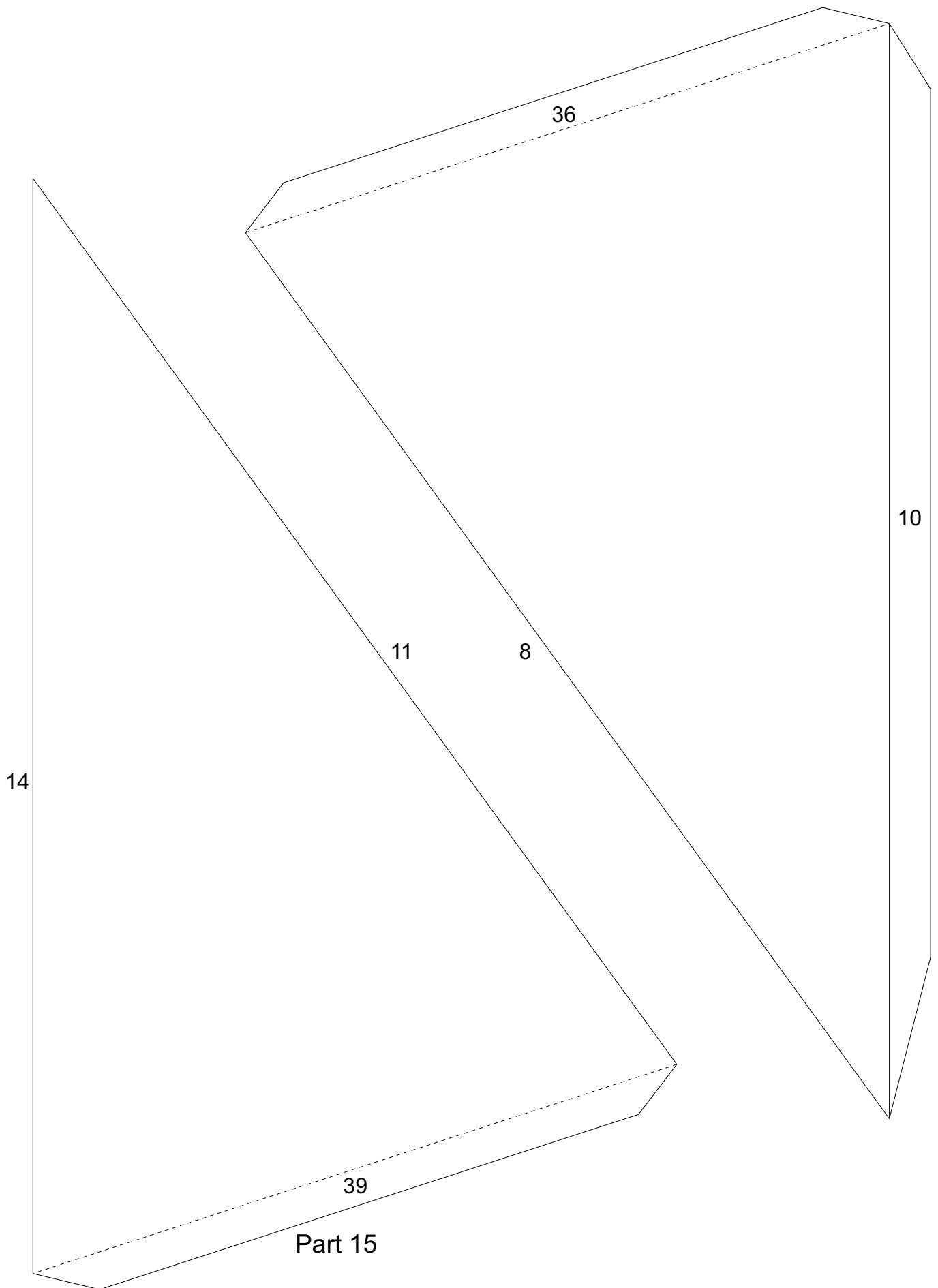

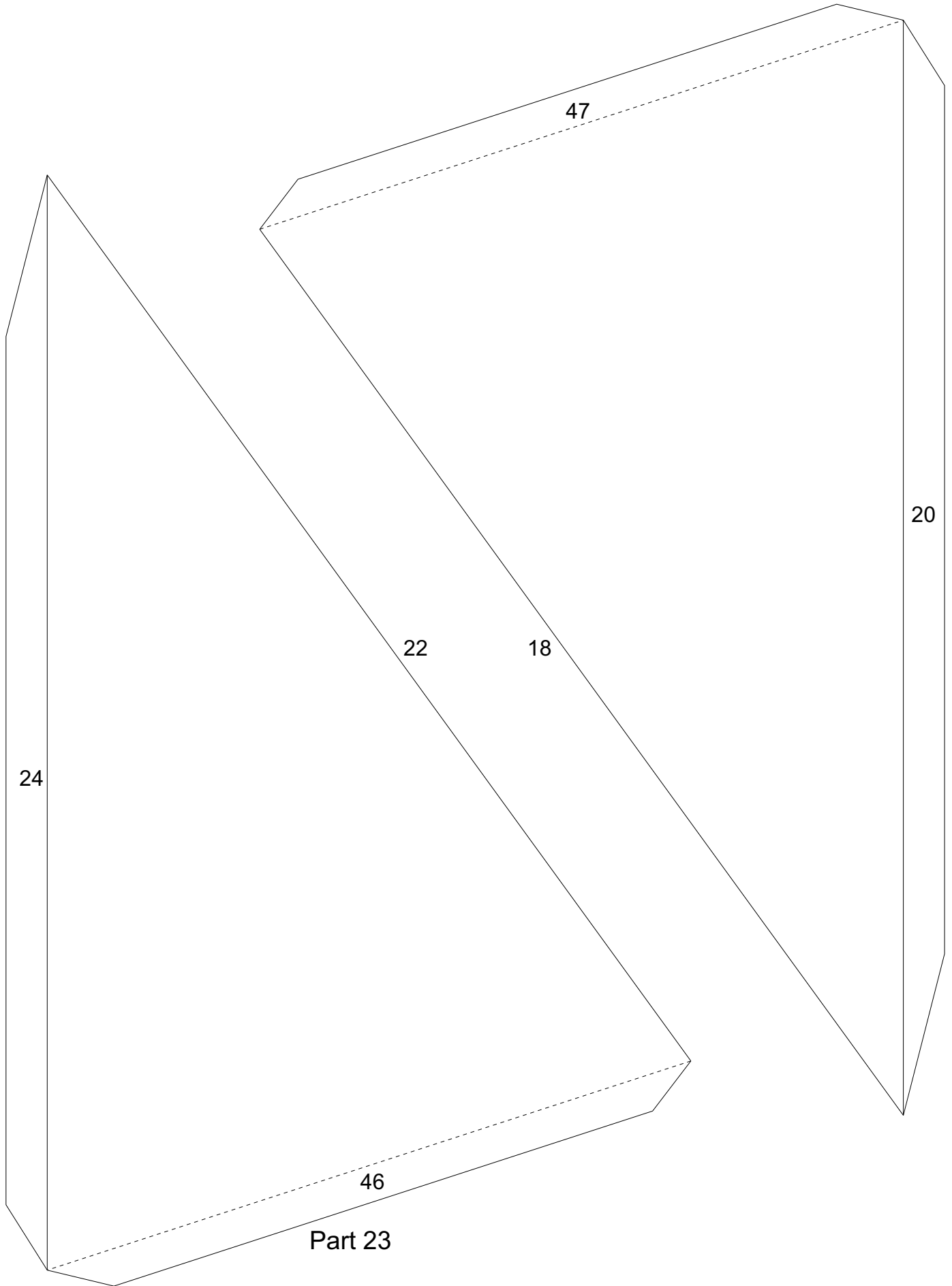

Small Stellated Dodecahedron

Color 4

Part 25

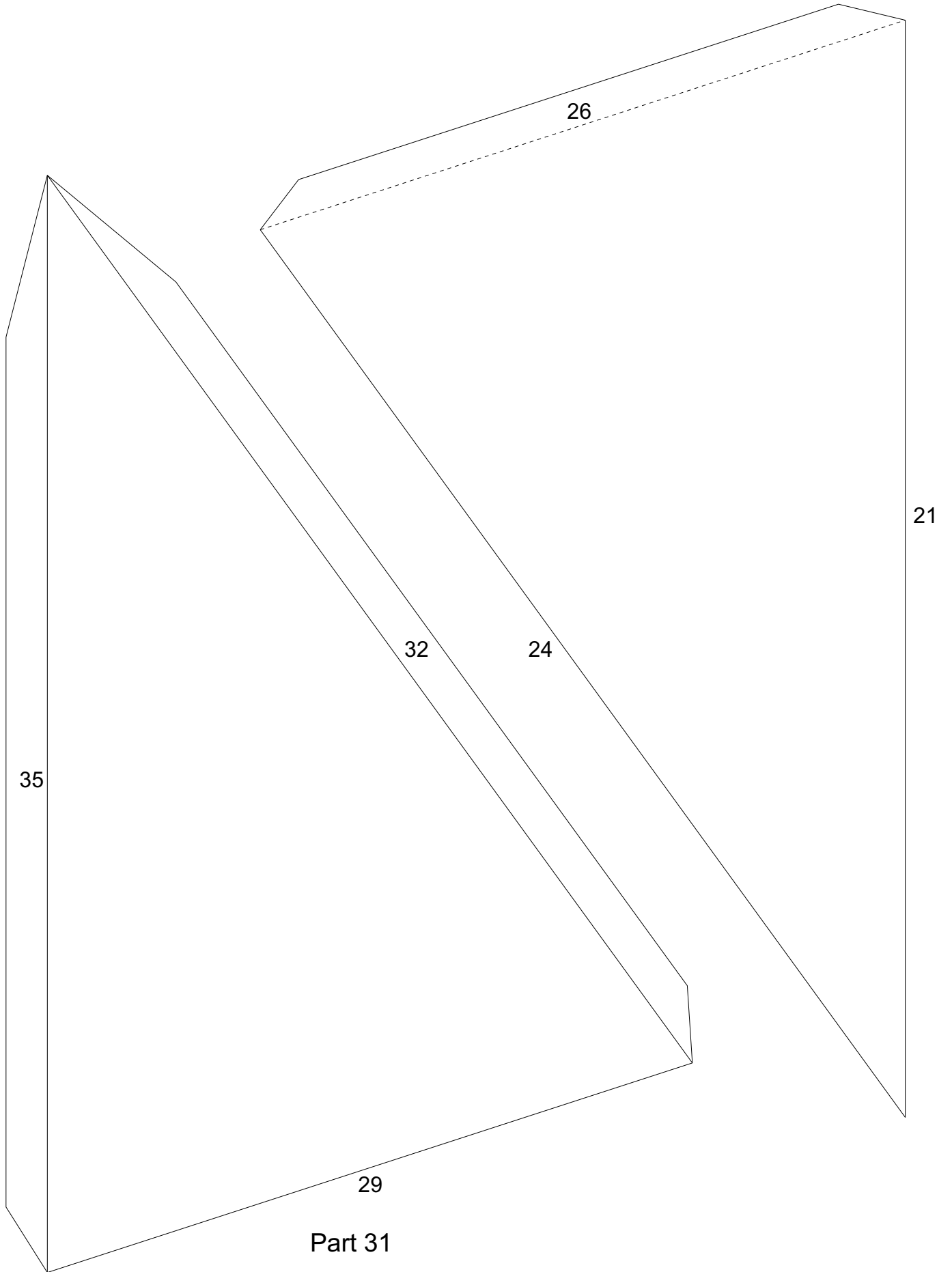

Small Stellated Dodecahedron

Color 4

Part 33

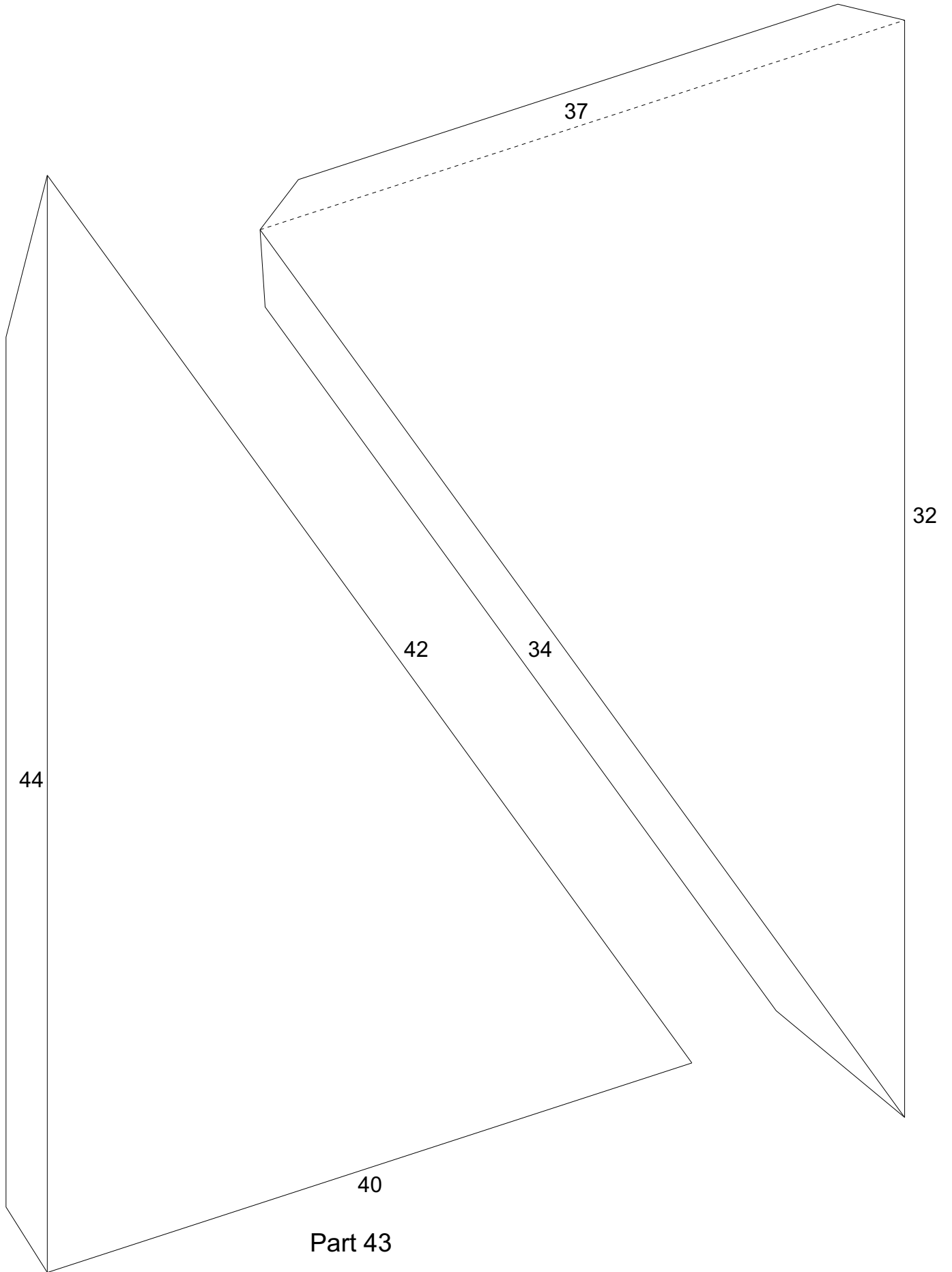

Small Stellated Dodecahedron

Color 4

Part 45

