

Christmas Tree

(Hexagrammic)

Part 1.1

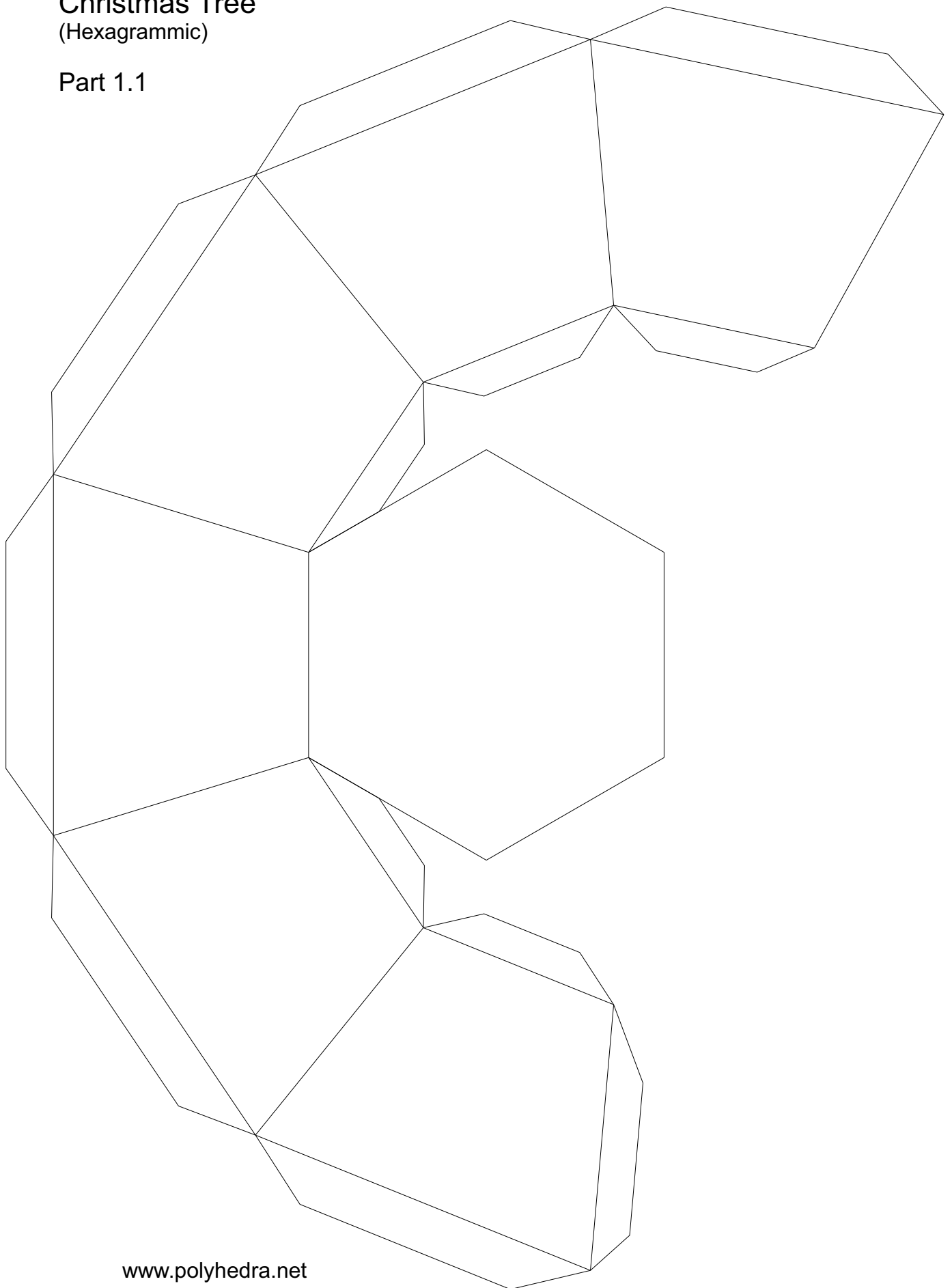

Christmas Tree

(Hexagrammic)

Part 1.2

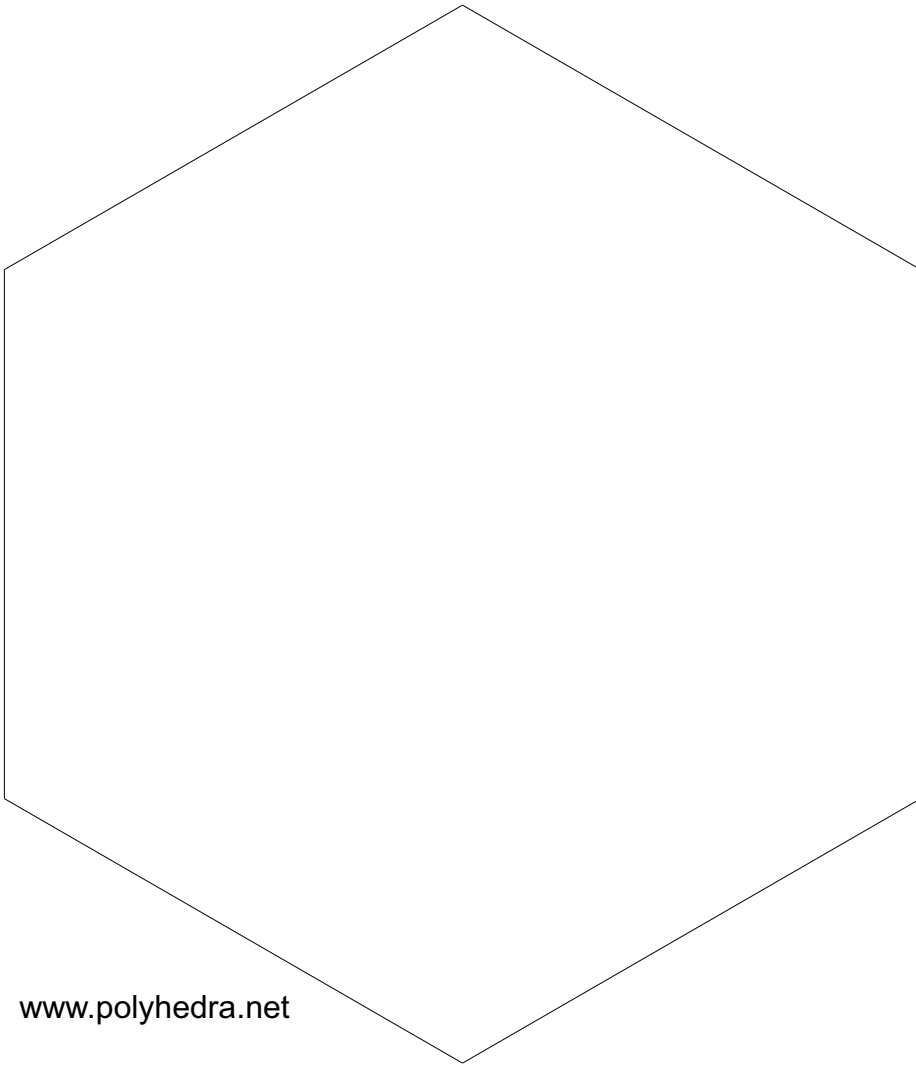

www.polyhedra.net

Christmas Tree

(Hexagrammic)

Part 2.1

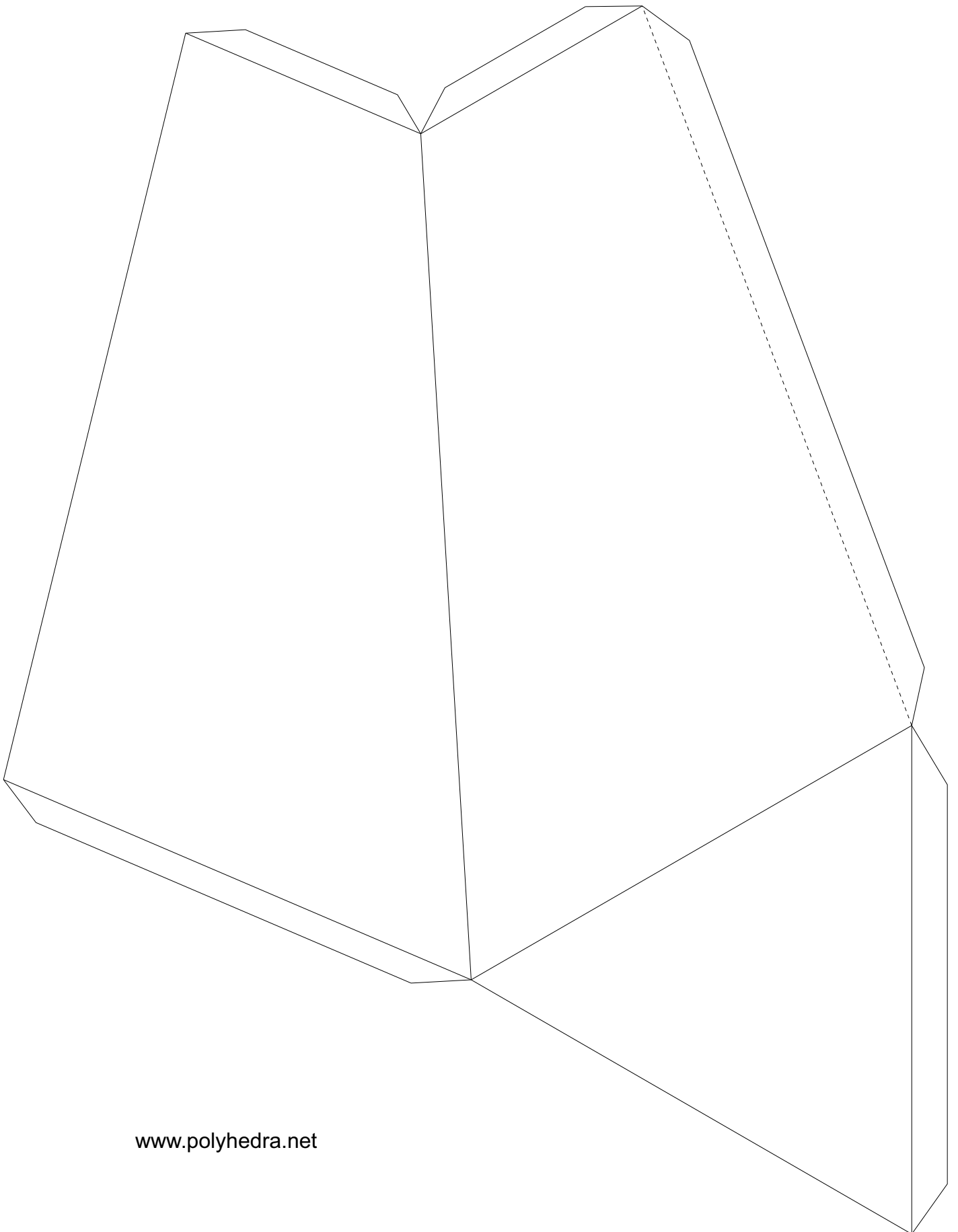

Christmas Tree

(Hexagrammic)

Part 2.2

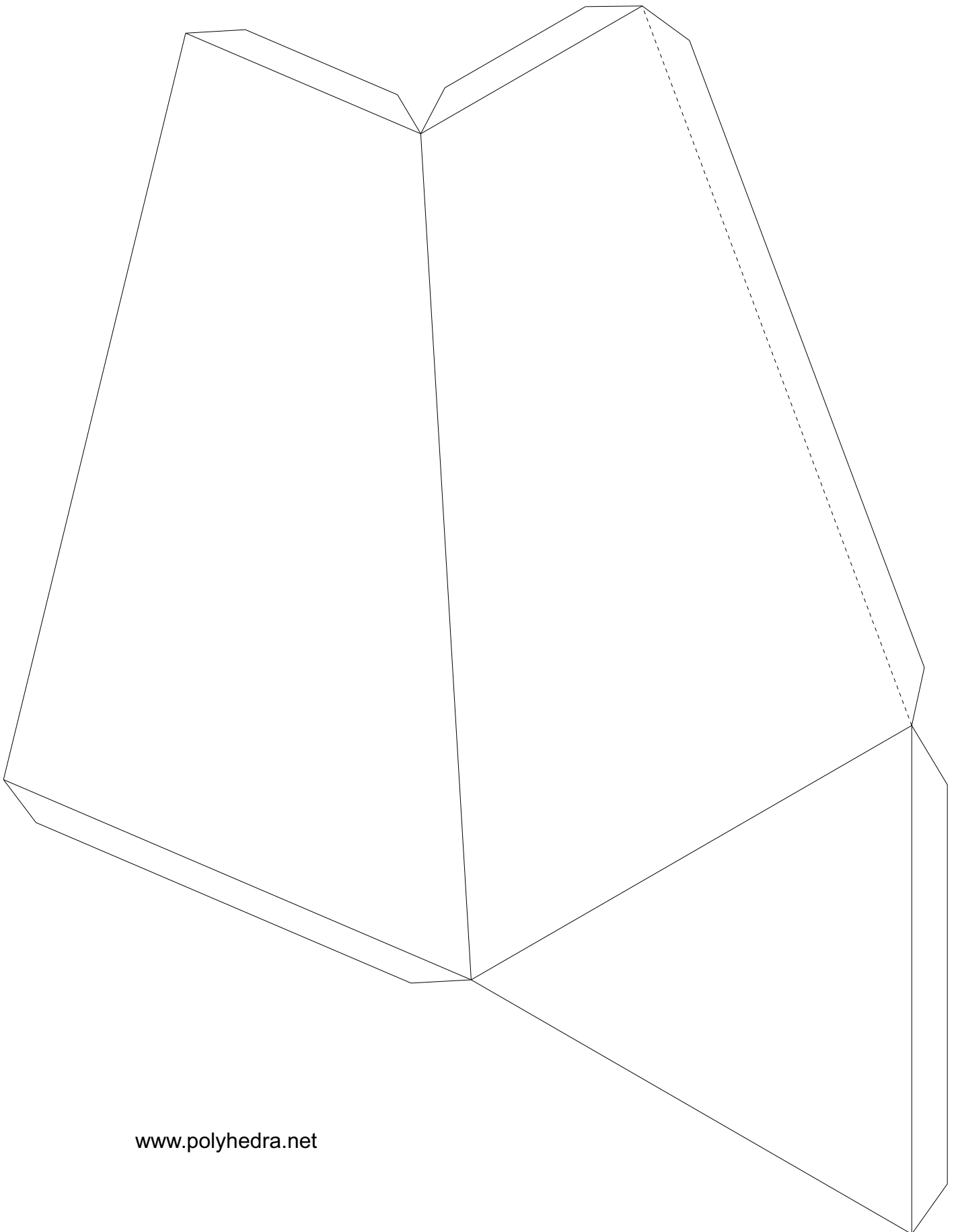

Christmas Tree

(Hexagrammic)

Part 2.3

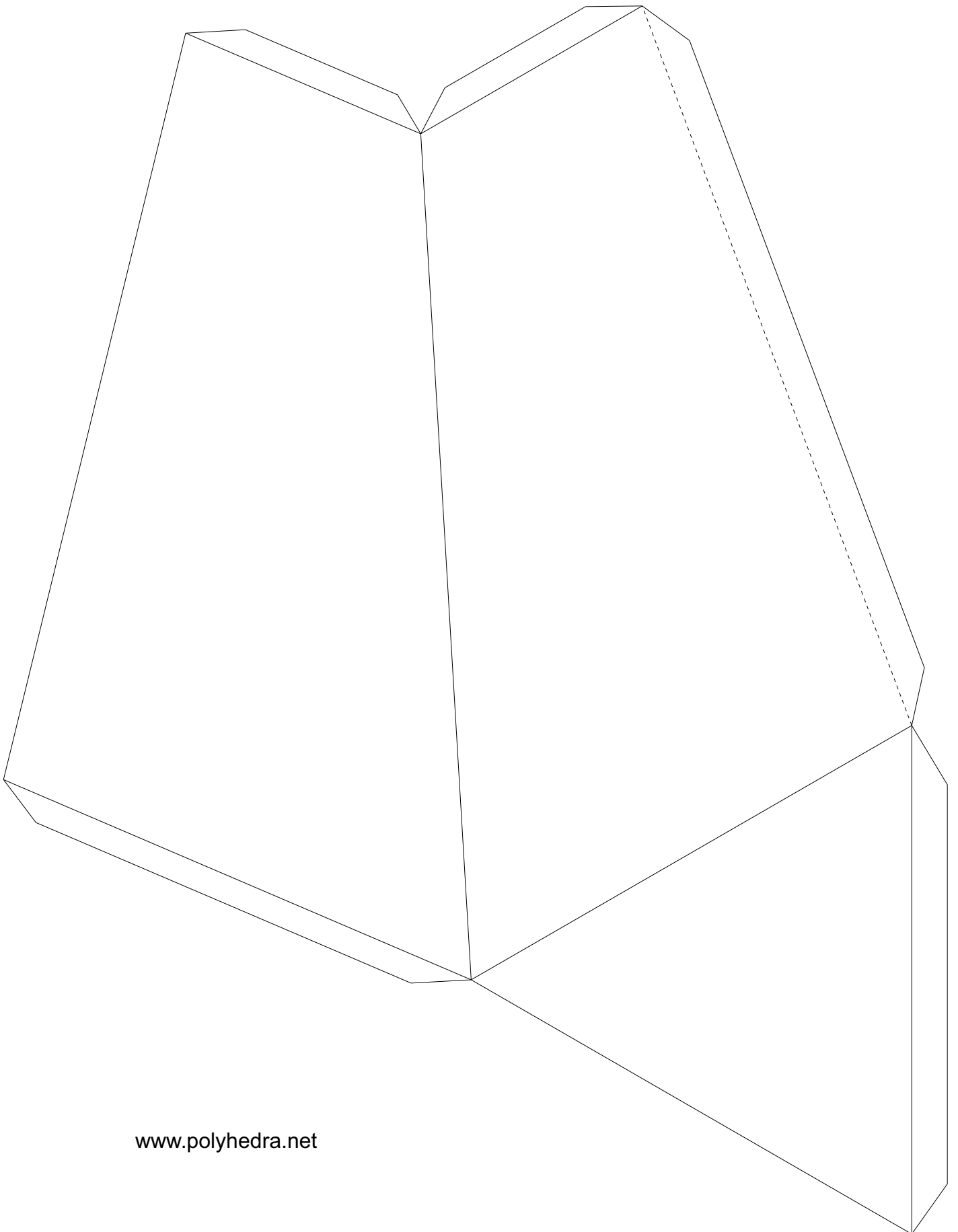

Christmas Tree

(Hexagrammic)

Part 2.4

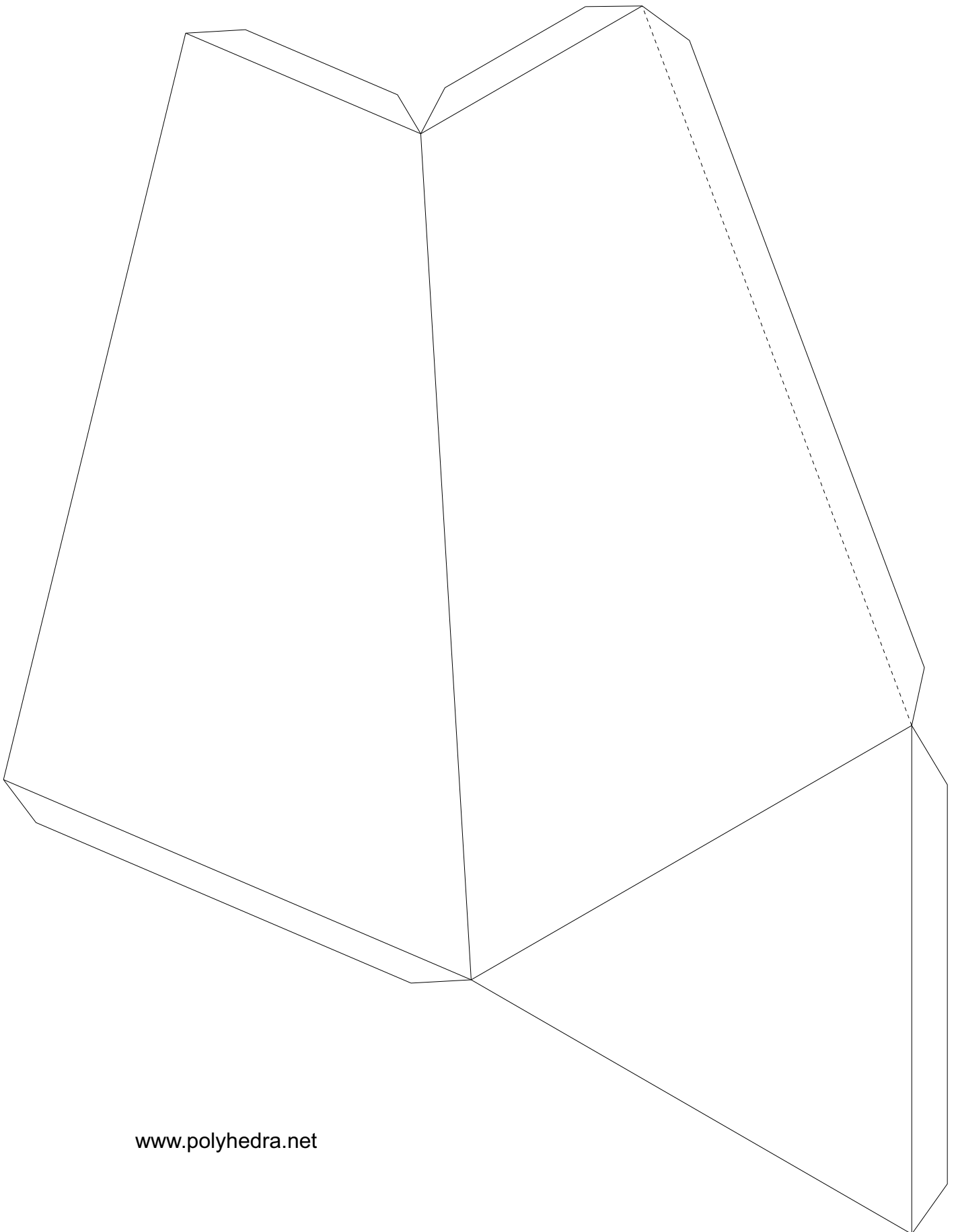

Christmas Tree

(Hexagrammic)

Part 2.5

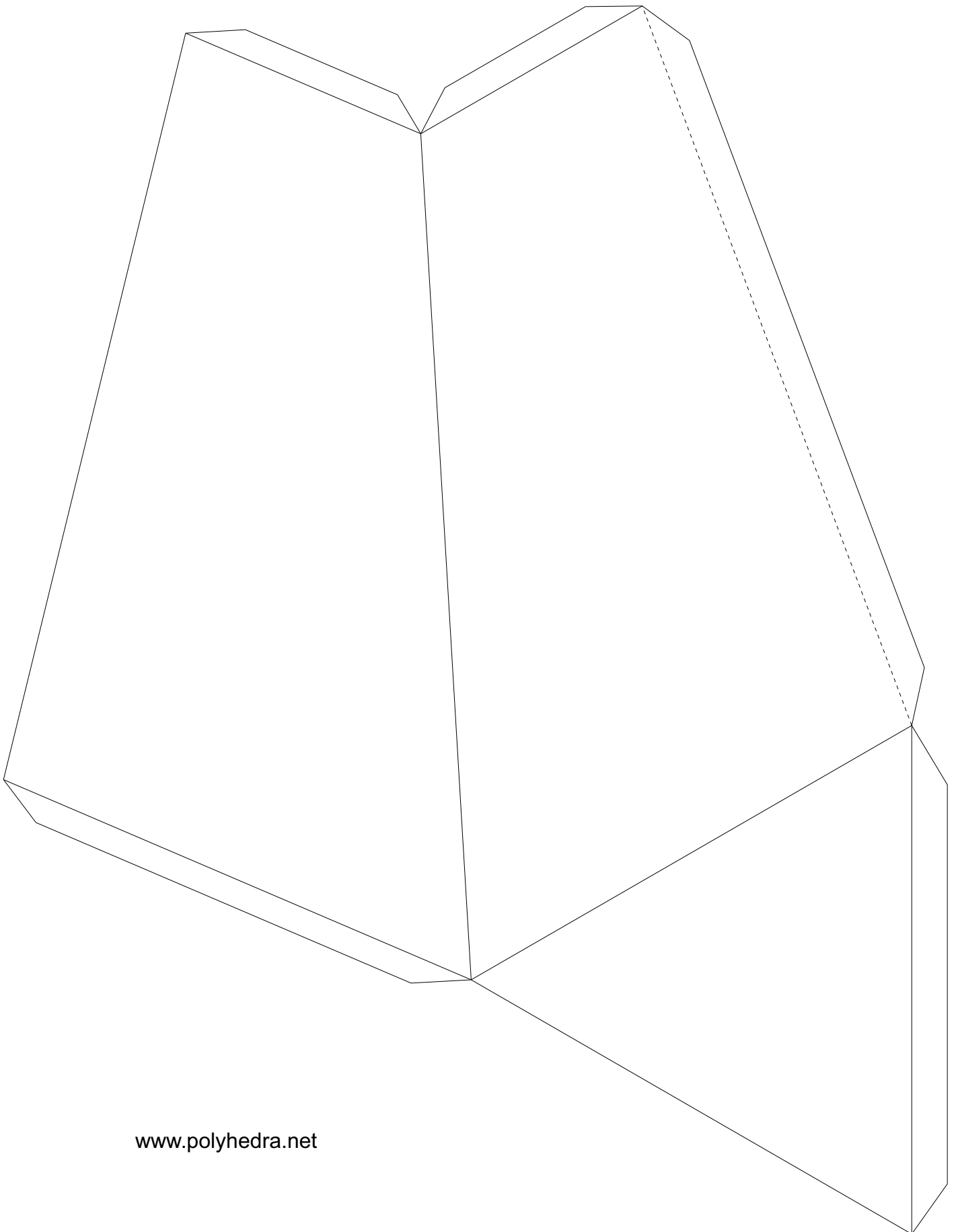

Christmas Tree

(Hexagrammic)

Part 2.6

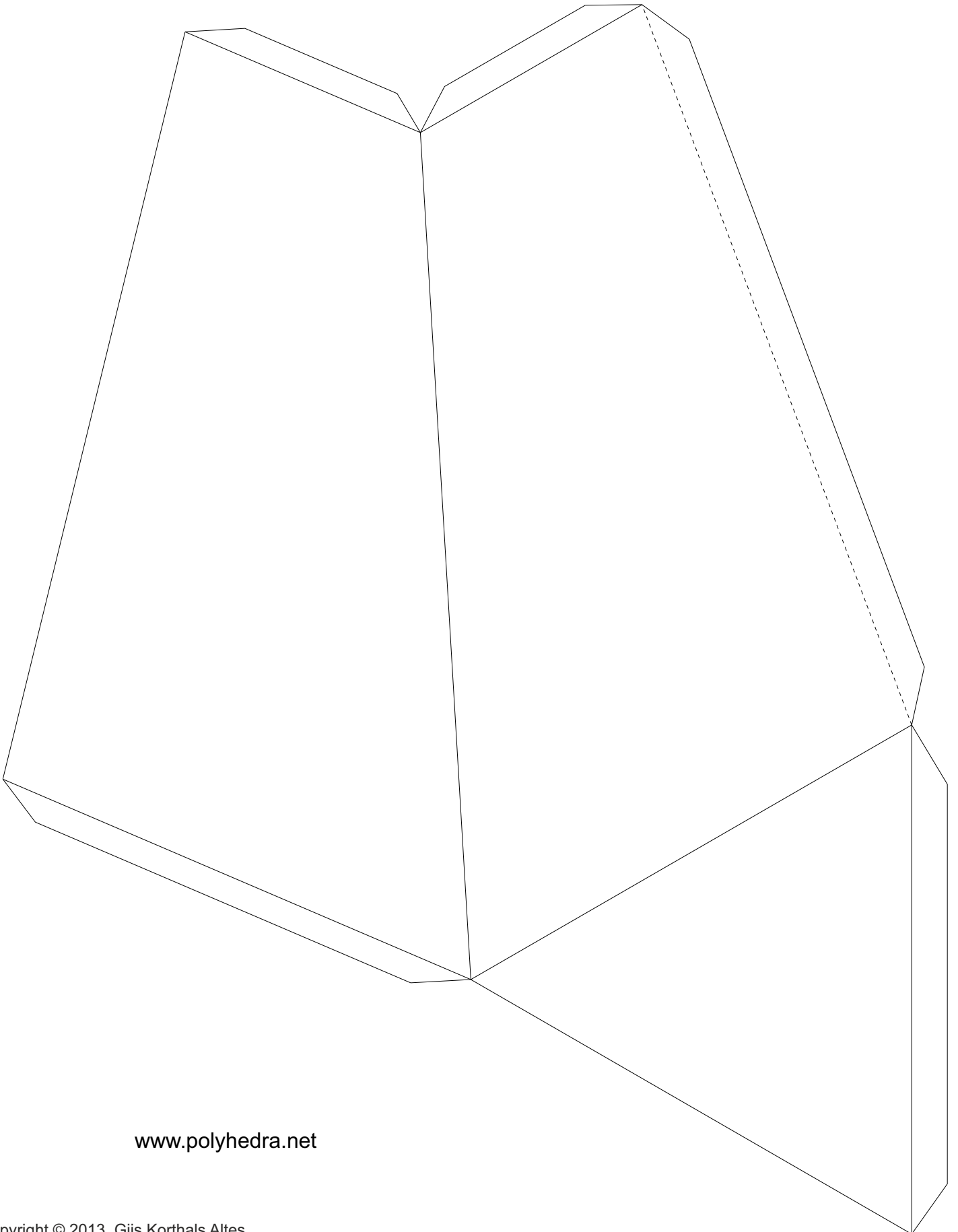

www.polyhedra.net

Christmas Tree
(Hexagrammic)

Part 2.7

x: cut out

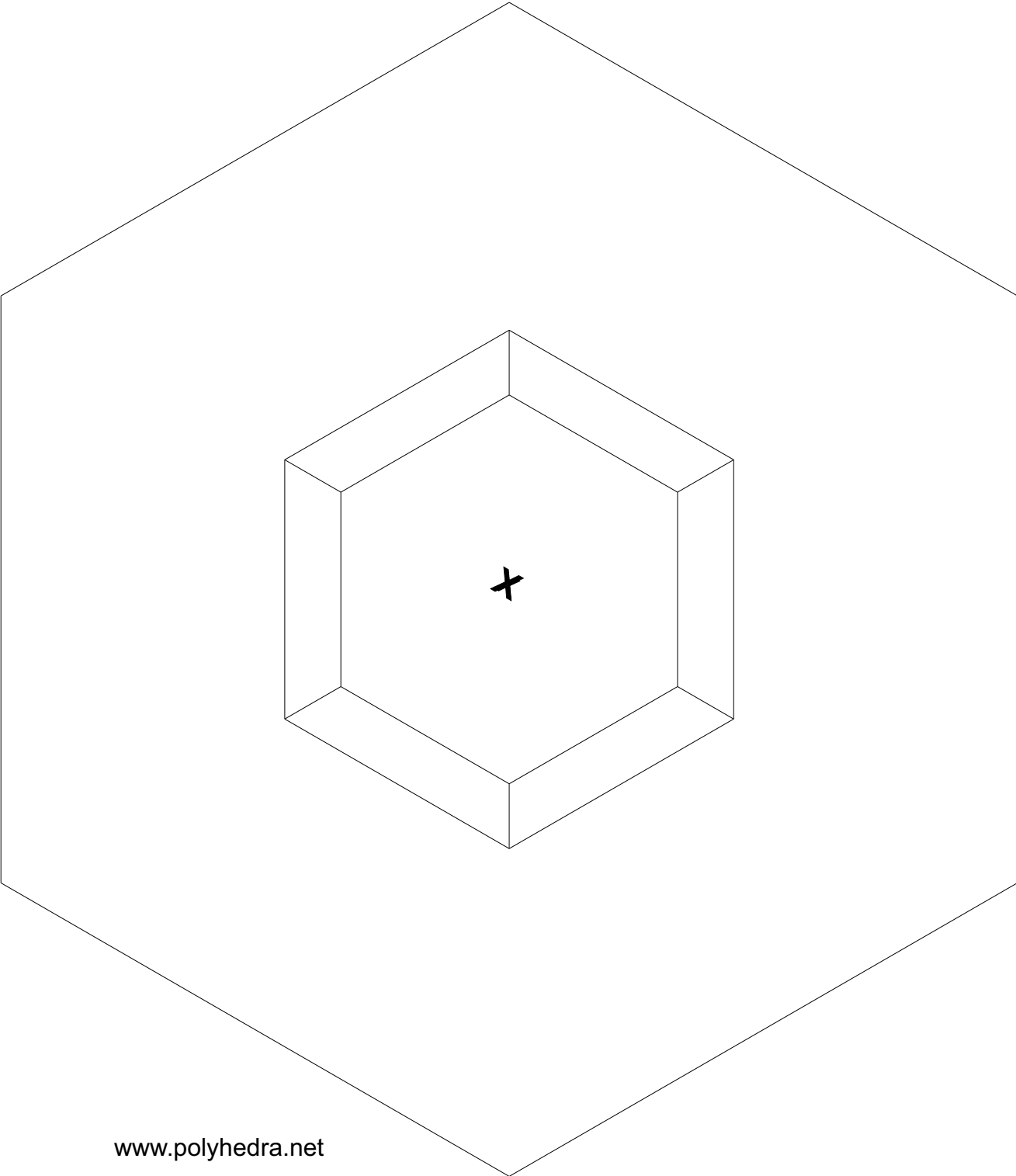

Christmas Tree
(Hexagrammic)

Part 2.8

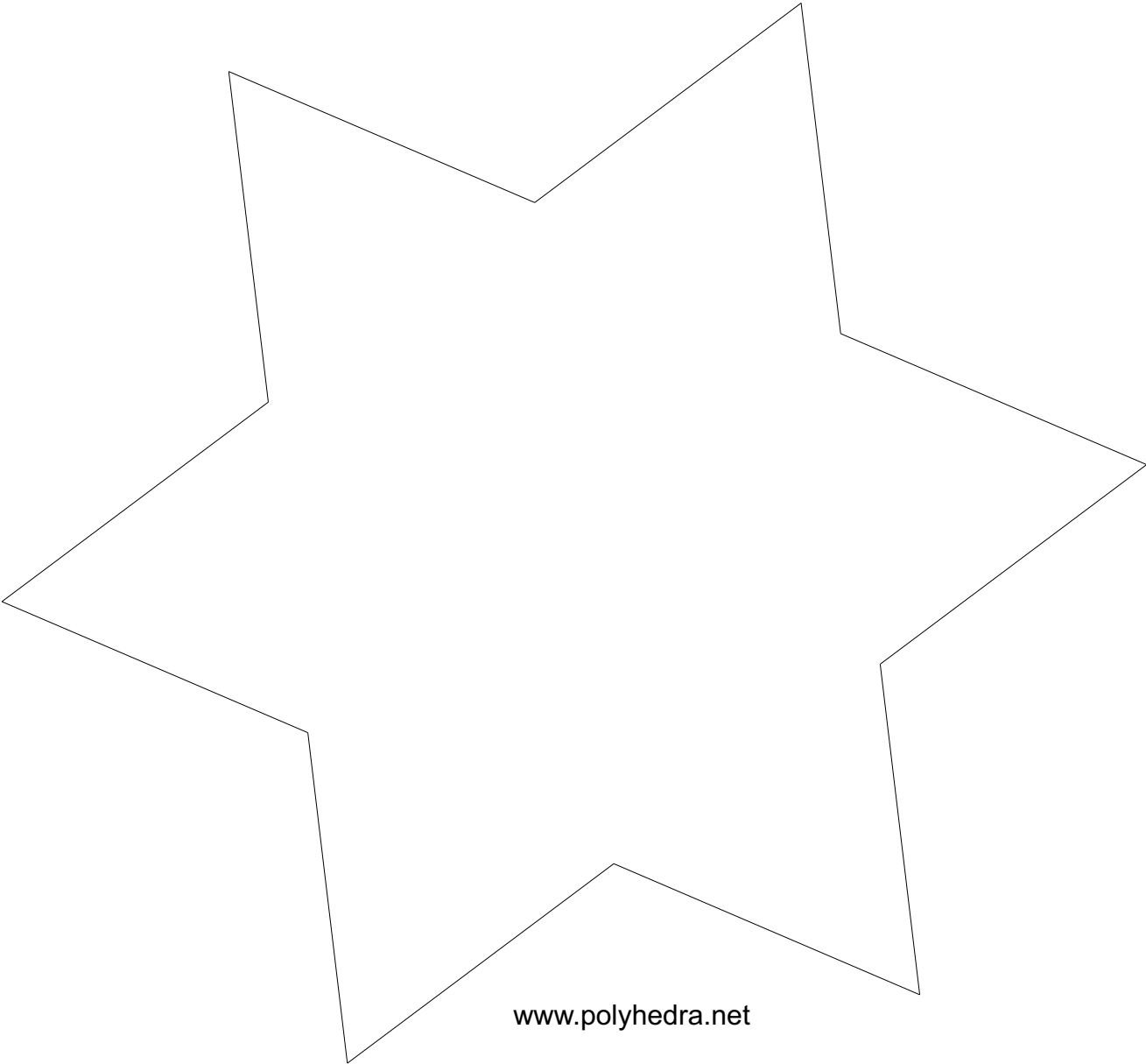

Christmas Tree (Hexagrammic)

Part 3.1

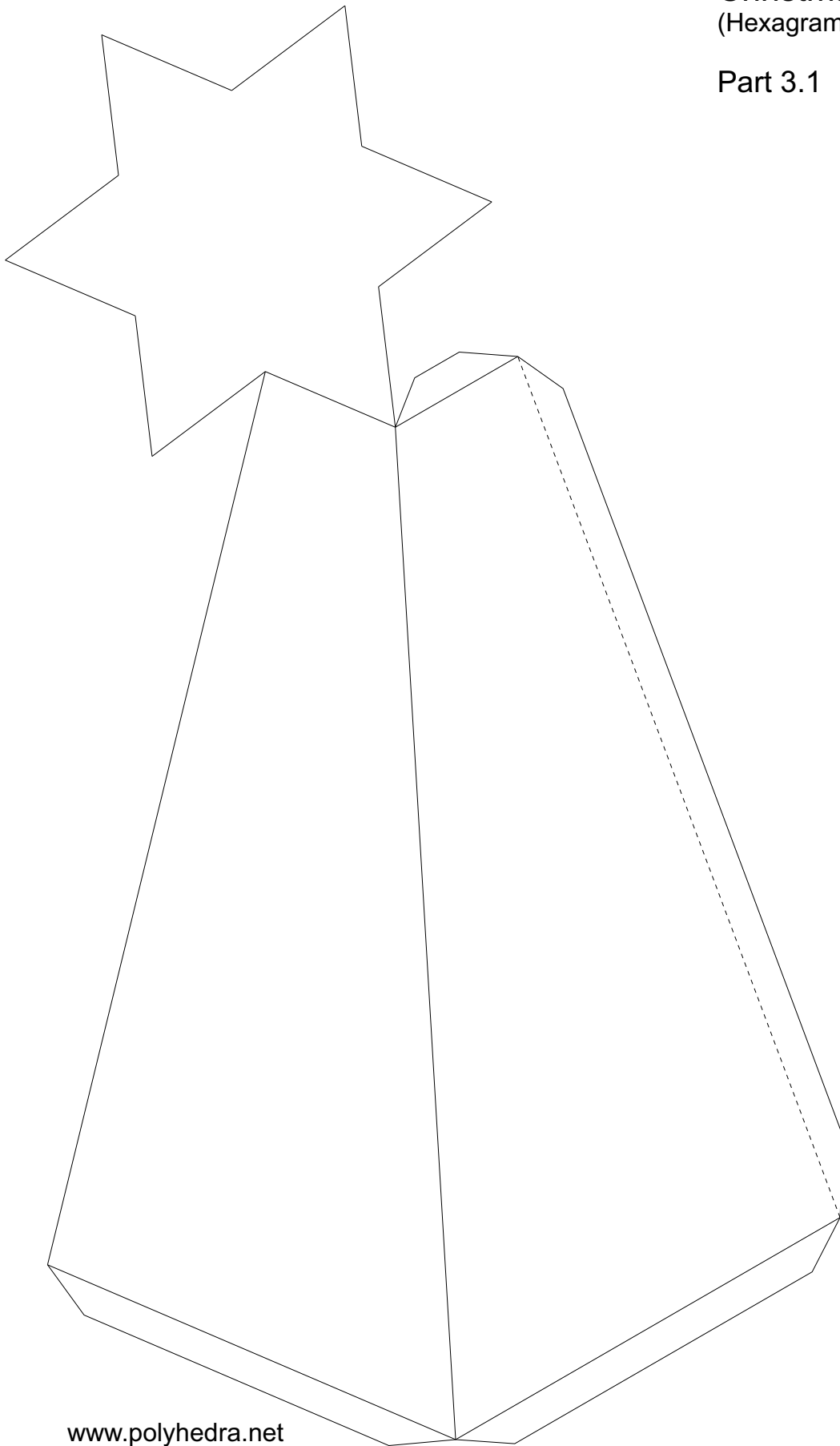

Christmas Tree
(Hexagrammic)

Part 3.2 and 3.3

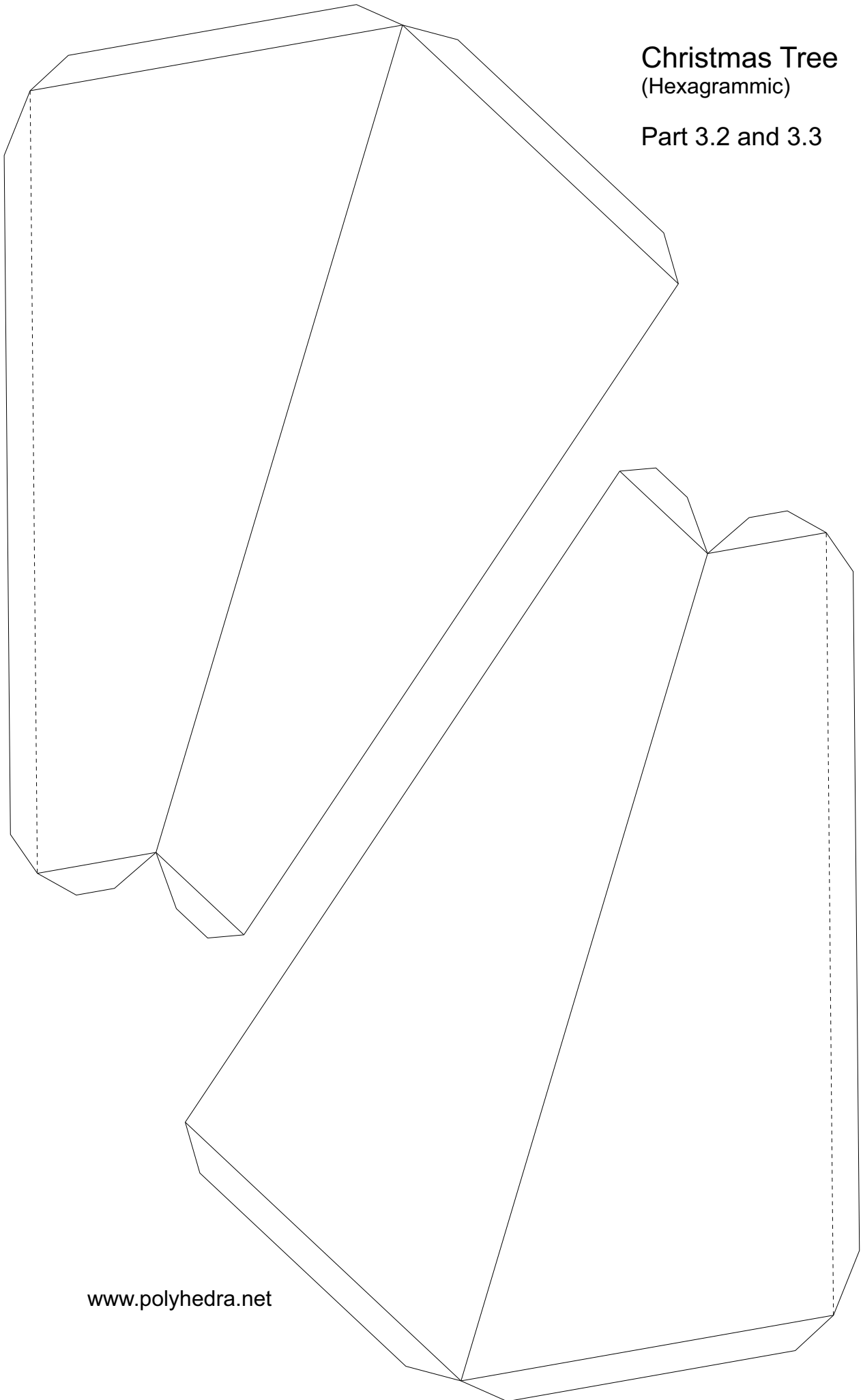

Christmas Tree
(Hexagrammic)

Part 3.4 and 3.5

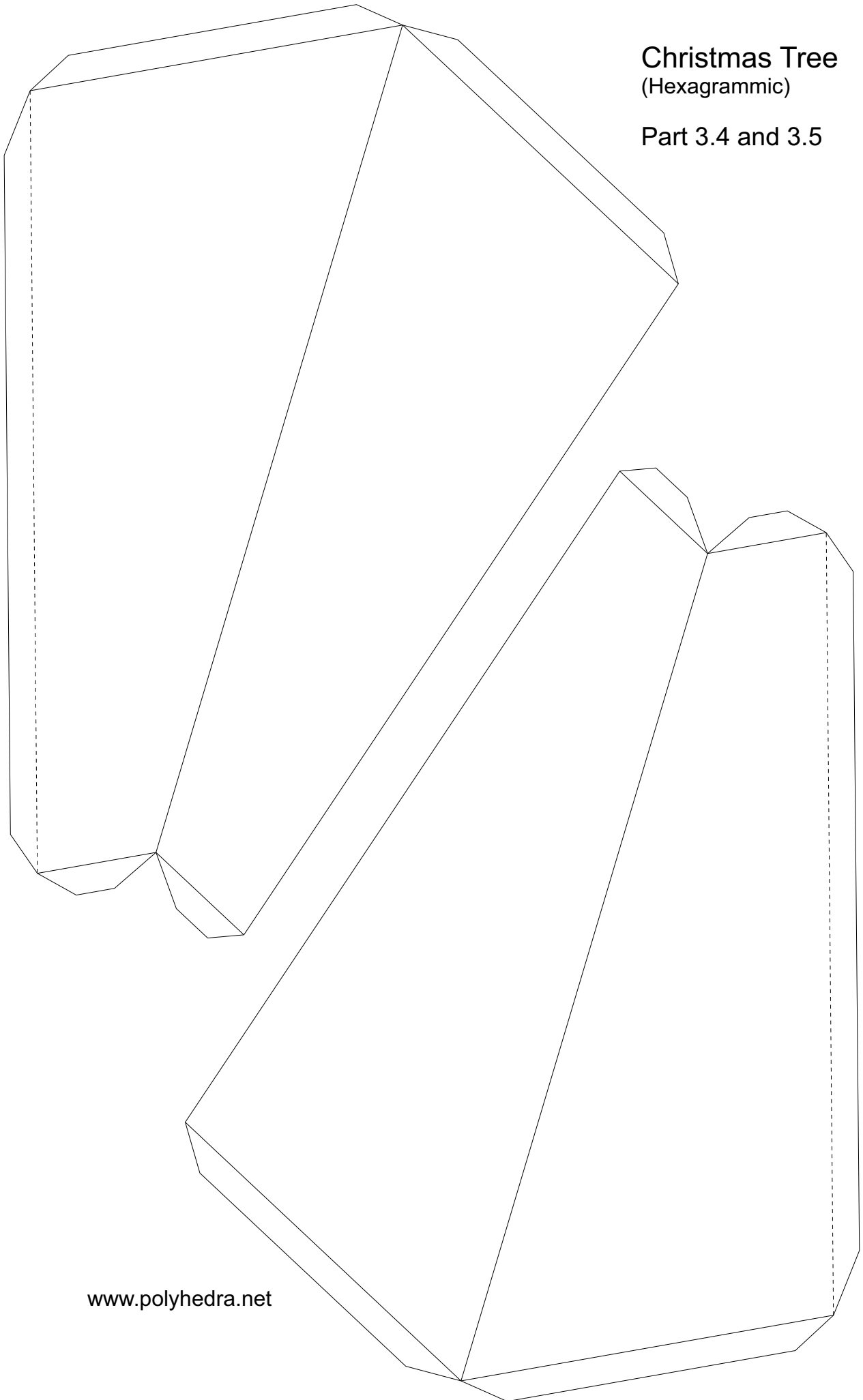

Christmas Tree (Hexagrammic)

Part 3.6

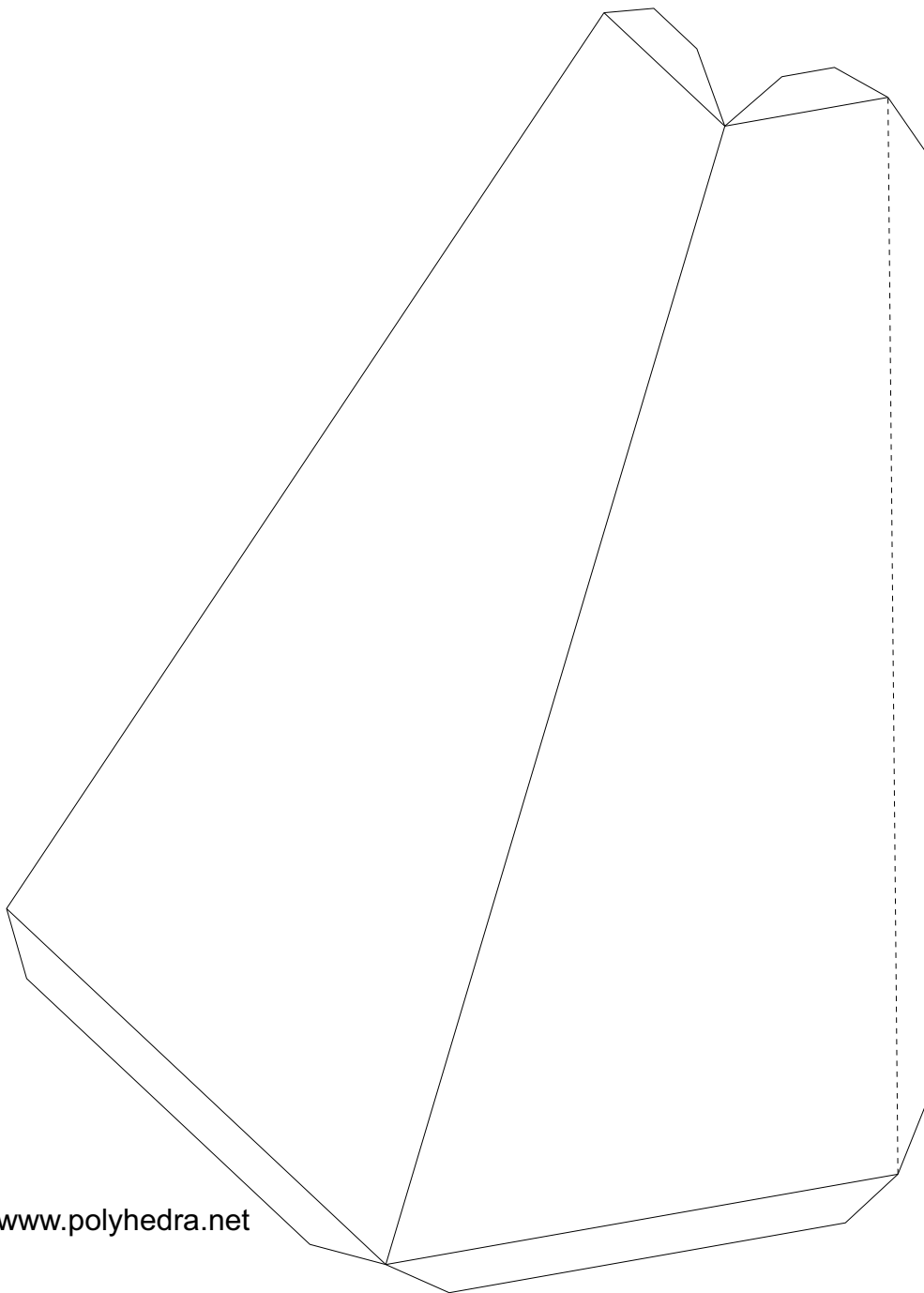

Christmas Tree (Hexagrammic)

Part 3.7

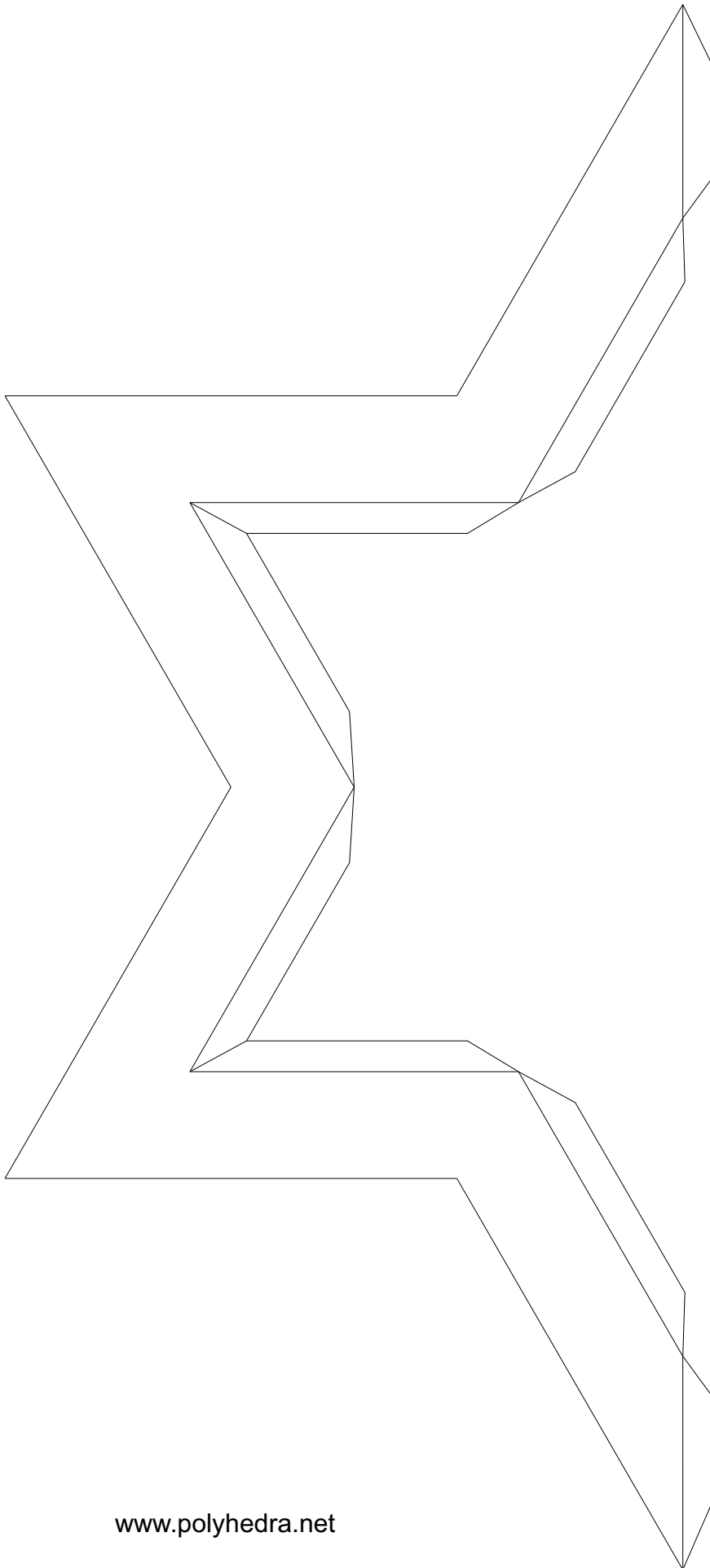

Christmas Tree
(Hexagrammic)

Part 3.8

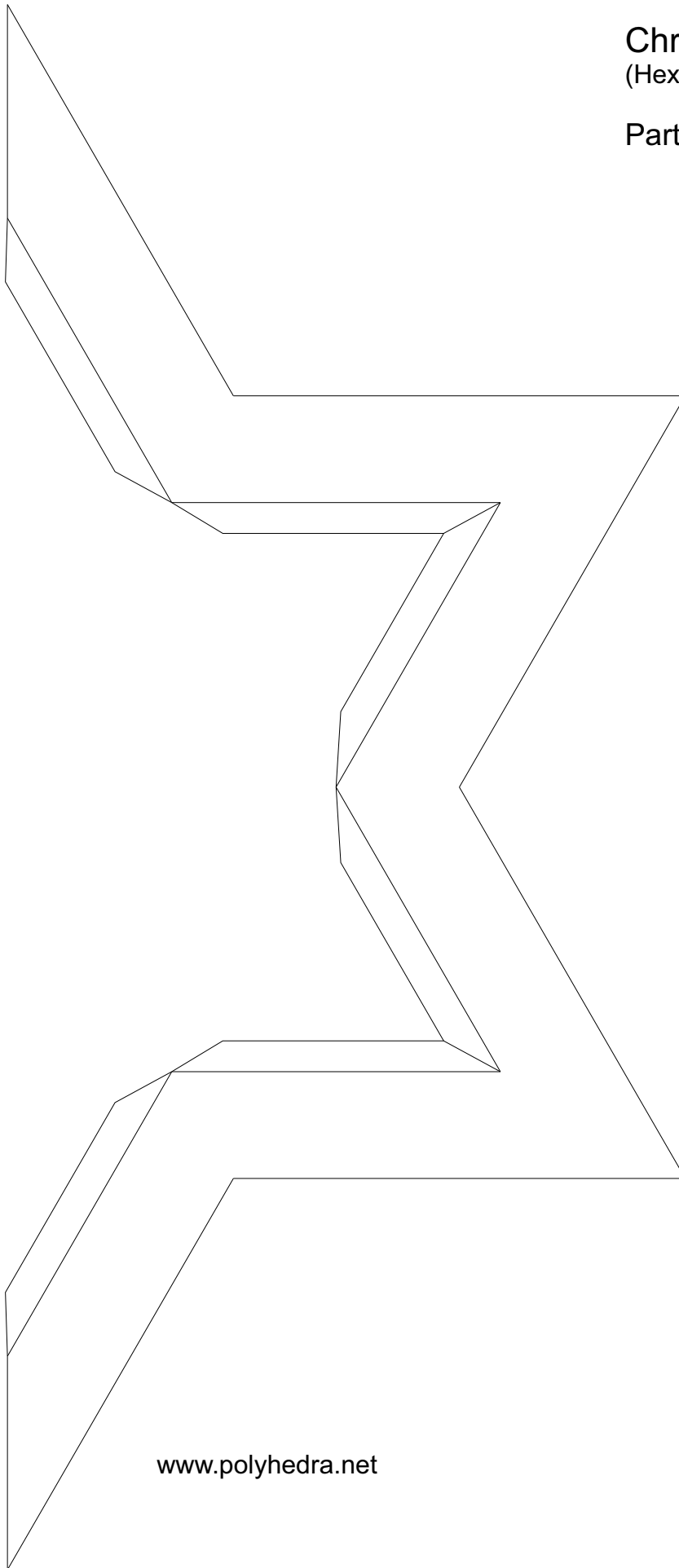

Christmas Tree (Hexagrammic)

Part 4.1

x: cut out

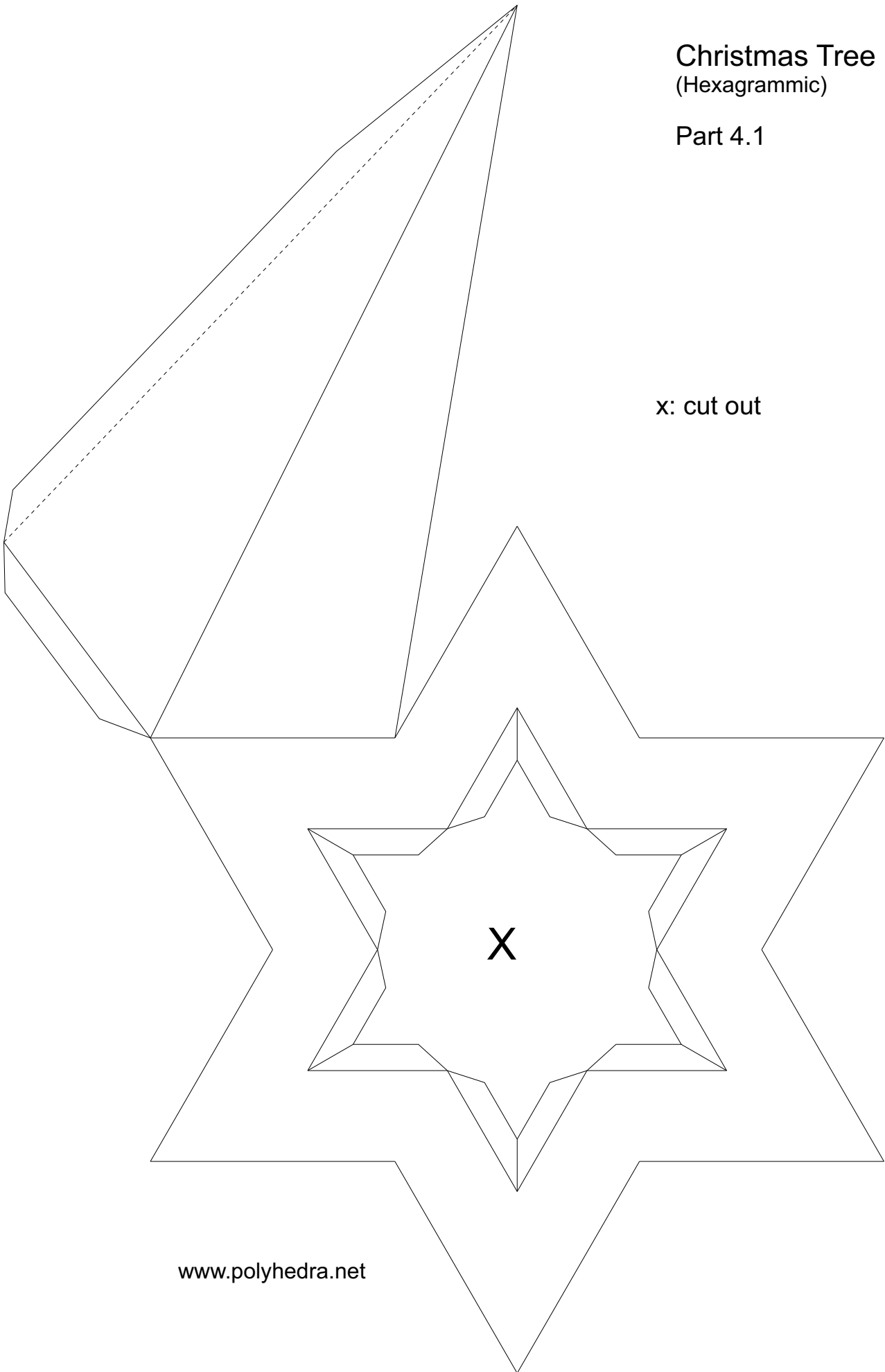

Christmas Tree (Hexagrammic)

Part 4.2

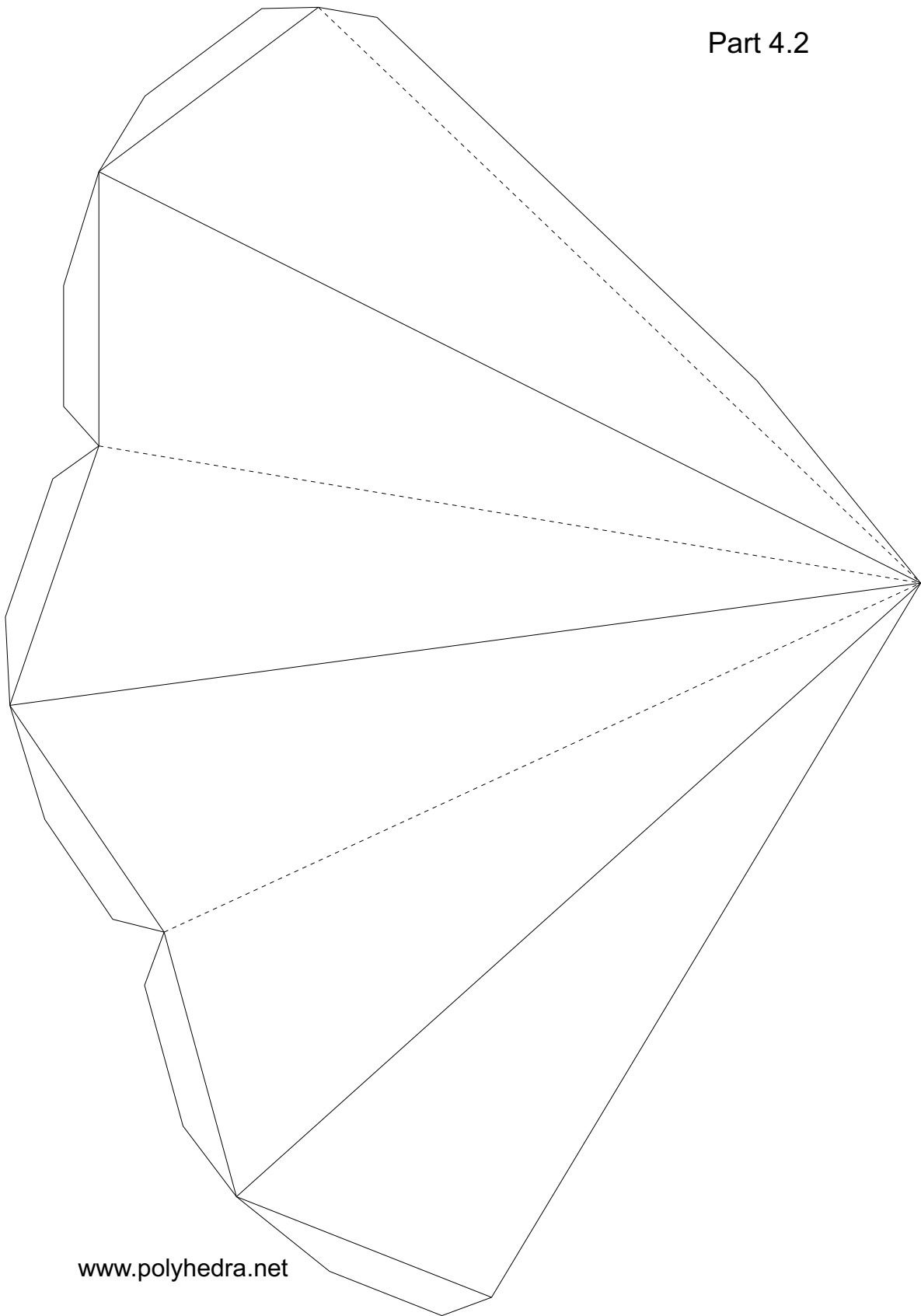

Christmas Tree
(Hexagrammic)

Part 4.3

